

www.vicaima.com

vicaima
HAUTE COUTURE

INTRODUCTION

VICAIMA HAUTE COUTURE LUXURIOUS & UNIQUE

Vicaima Haute Couture offers luxuriously stunning pieces expressed in two distinct Collections: Black & White and Makassar. These unique Collections invite you to journey through charismatic material and design, where the glamorous and daring models compliment outstanding décor. Inspired by the spirit of haute couture, they elevate the humble door to a delightful decoration piece in its own right, acting as a focal point, and transcending its purely basic function.

In Black & White, a masterly sense of line is imposed by each vibrant style whose designs are so powerful they create an optical shock within its surroundings. The art of contrast is expressed in the glamour of black or in the purity of white. So intense, this collection creates an air of mystery and sensuality.

The Makassar Collection, has a superb aesthetic which combines the warm tones of luxurious ebony veneer with hand crafted golden detailing, intersecting striking volumetric shapes. Each model has been imbued with a dramatic and luxurious persona, with meticulous attention to detail, creating individual and innovative designs.

Able to surprise and to seduce, Black & White and Makassar Collections, combine premium materials with high quality manufacture and represent a masterpiece in modern interior doors.

Vicaima Haute Couture celebrates more than 50 years of experience at Vicaima, and brings the passion and the art of working quality materials, in a creative expression with innovative vision.

CONTENTS

05

BLACK & WHITE COLLECTION

is a symbol of sophistication and dynamism, which rises to the pinnacle of design reinventing graphic lines and geometric shapes. Each of the 10 vibrant models, creates a striking uniqueness, inspiring a bold and mysterious environment. All models exhibit an edge of red, a charming detail which distinguishes the collection and becomes its brand identity.

29

MAKASSAR COLLECTION

reveals a rich and refined environment. With a striking aesthetic, the design inspired by the art deco style, suggests stylized volumetric shapes that give life to six exclusive models. The natural beauty of ebony grain configuration hand crafted with golden metallic detailing and the sophisticated handle, creates a gorgeous and dramatic design.

43

ALL COLLECTION

47

TECHNICAL DRAWING

51

PRODUCT INFORMATION

52

CONTACTS

BLACK & WHITE
COLLECTION

The art of contrast. Powerful pieces that reflect spirit, refinement and sensuality. The designs, distinctively, set a rhythm and create a personality.



N01

Optical Art. White on black, the spirit of the sixties. Invigorating and vibrant geometry demonstrating the strength of personal expression. For those who like games, it is one of contrasts – symmetry challenging asymmetry.

N02

Black on white. Again the strength of personal expression, but now depicting itself with lightness. Here the door somehow becomes a space between two spaces.



N01

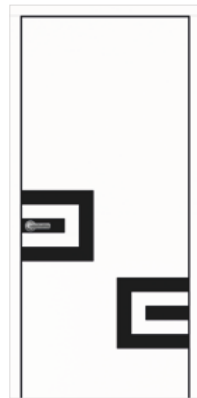

N02





N03

The strength of the simplicity. A variation on a visual strength, evoking perhaps a feel of movement.

N04

Minimum art. Purity, rigidity and balance. A subtle appreciation of beauty whilst being entirely functional. Simple architectural elegance that stands out so effectively.



N03

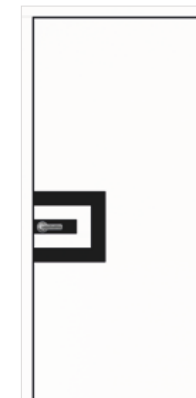

N04

N11

Zen. The circle, symbol of perfection, eternity and wisdom. A simple yet dramatic creation from the Orient, simultaneously majestic and serene.

N12

Variation on the theme. The white changes the perception of the space and emphasizes the idea of movement.



N11



N12





N13

Style exercises. A visual shock treatment. The strong intensity of the line interrupted by a natural break that in no way mars its directness.

N14

Symphony in white. The interrupted line acquires an impressive visual strength.



N13



N14



N15

Double the impact. A simple device that divides yet harmonizes space in a truly simple way.

N16

Black on white, the double impact stands out more becoming starkly simple.



N15



N16





N17

Shadow and light. In Art Deco style, the materials used produce a distinct harmony of transparency and opacity.

N18

The subtle choice of materials gives priority to light. The glass with all its clearness is enhanced by the radiance of pure white.



N17

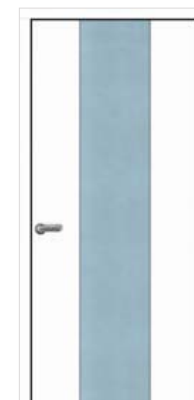

N18

N21

A design refined to its utmost, a door that stands apart with self affirmation by its volume. The righteous balance between minimalism and presence.

N22

The purity of the white reveals the shapes, the audacity of the volume is subtly insinuated.



N21



N22



DIAMOND
SHAPE RUNS



N23

The meeting of lines suggests little squares that stand out in design, giving three-dimensionality to a flat material. The squares seem to vibrate with lightness captured in the light itself.

N24

Sophisticated, the design alludes to a standard that dominates the sumptuous surroundings. The crossed game of lines recreates a linear but symmetric environment.



N23



N24





N25

Irreverent, this model creates intense impact by design contrasts. A precious jewel motif distinctively sets a rhythm and creates a personality.

N26

The diamond shape that runs throughout the model accurately projects a strong dynamic and unique space in which it operates.



N25

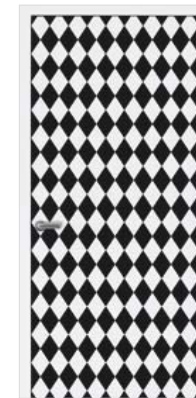

N26

N27

The link between squares and diamonds suggests the presence of overlapping cubes and a vibrant and impressive visual effect.

N28

A game of optical illusion is suggested by the multiplication of geometric patterns and by the merger of two figures.



N27

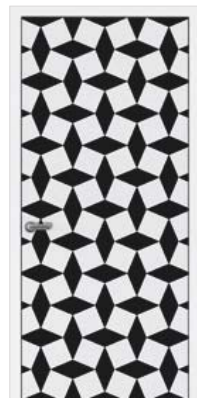

N28



MAKASSAR
COLLECTION

A unique collection that combines all the cultural heritage of a
luxurious material with an innovative design.





SINUS

Stunning in its brightness and contrast, the Sinus is crossed by strong horizontal lines interspaced by even and linear textures.



AXIS

Axis is a geometric model cut by a single metallic vein. With the true personality of an artistic object, Axis strengthens the entire decoration of an interior environment.

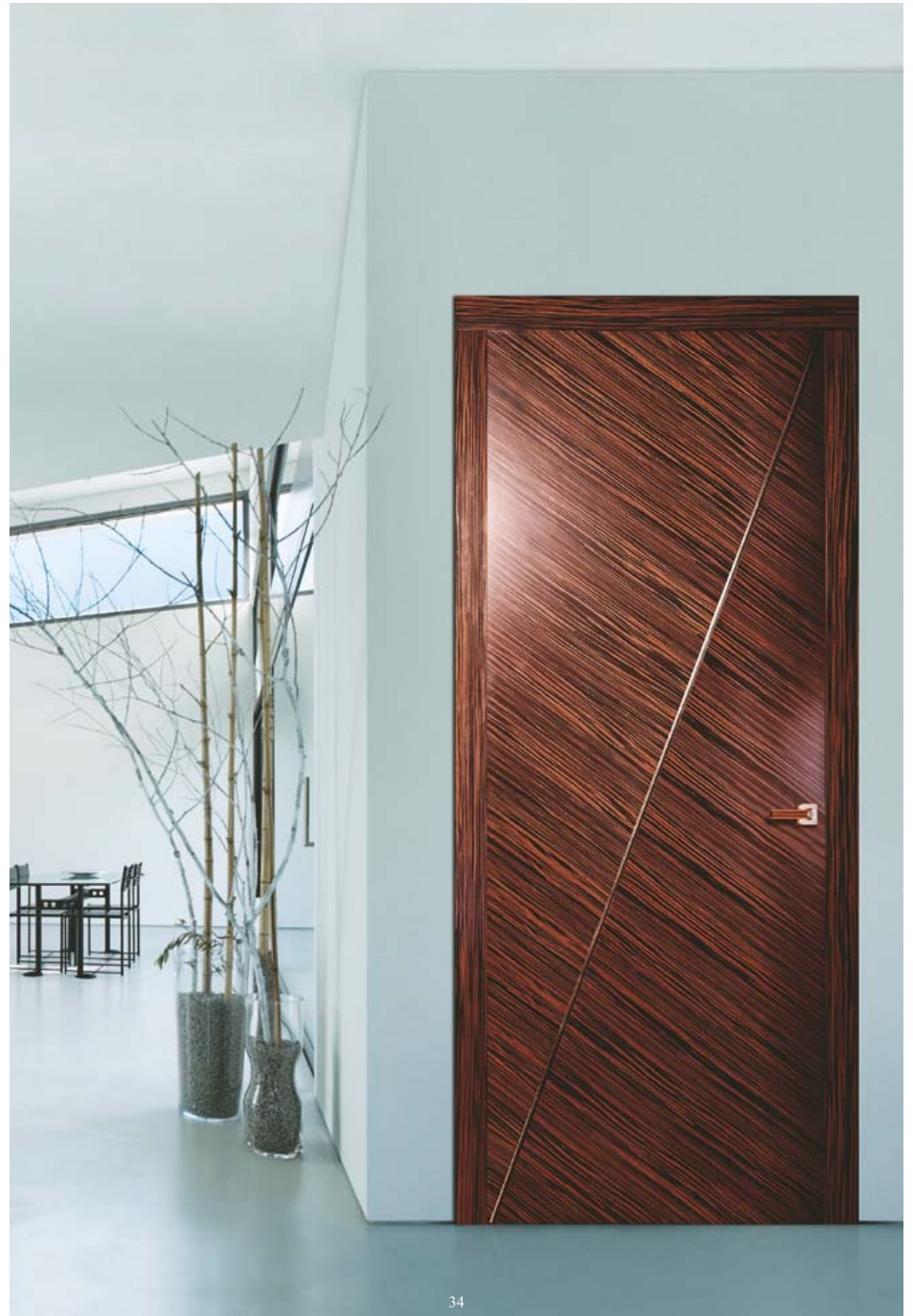

RADIAN

Vertical in their division, the Radian presents a striking geometric design, enhanced by the subtle use of gold along their lines.



RAYON

A strong diagonal line divides this model, all converging design and intersecting to a midpoint. Simple in design, the Rayon radiates good taste.





GÉODE

Strong in its presence, the Geode, is marked by an intense vertical line that runs throughout the model. The shape is greatly enhanced by the horizontal characteristic of the wood grain configuration.





Arc

Fun and beguiling Arc is reflected in its numerous vertical layers and the contrasting richness of its various textures and reflections.



ALL
COLLECTION



BLACK & WHITE
COLLECTION



N01



N02



N03

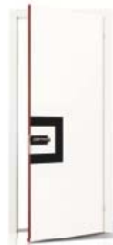

N04



N11



N12



N13



N14



N15



N16



N17

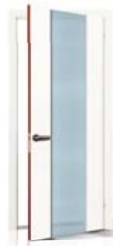

N18



N21



N22

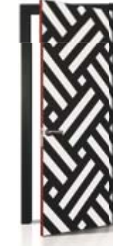

N23



N24



N25



N26



N27



N28

MAKASSAR
COLLECTION



Radian



Rayon



Axis



Géode



Sinus



Arc

**BLACK & WHITE
COLLECTION**
Technical drawing

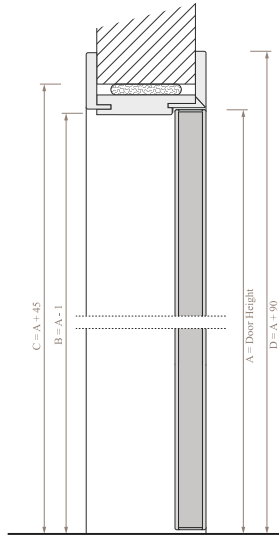

Key : A - Door Dimension | B - Free Passage | C - Structural Opening | D - Frame Dimension

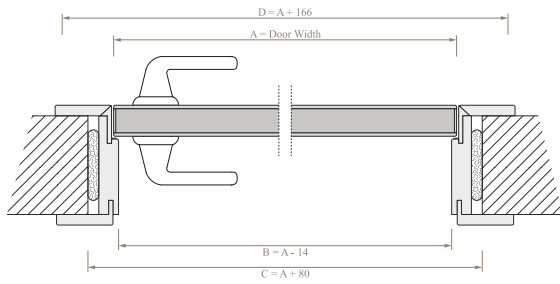

Note: Please confirm dimensions with our technical support before placing your order.

**BLACK & WHITE
COLLECTION**
Sliding door

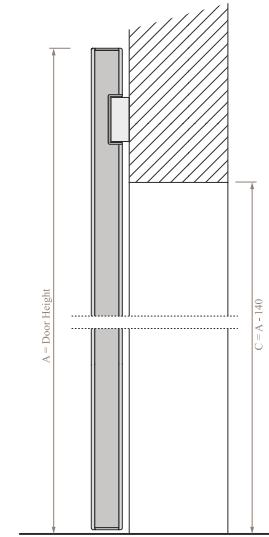

Key : A - Door Dimension | C - Structural Opening

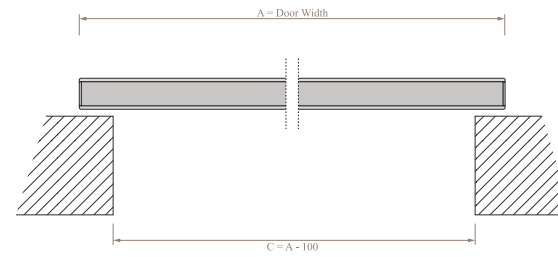

Note: Please confirm dimensions with our technical support before placing your order.

**MAKASSAR
COLLECTION**
Technical drawing

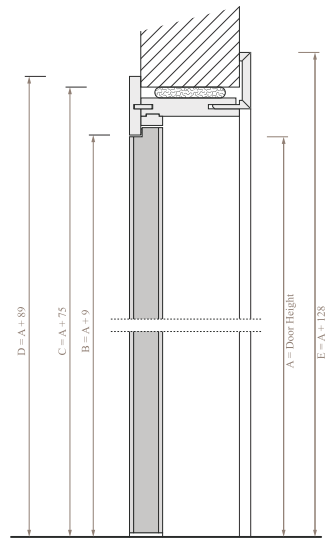

Key : A - Door Dimension | B - Free Passage | C - Structural Opening | D - Frame Dimension | E - Frame Dimension

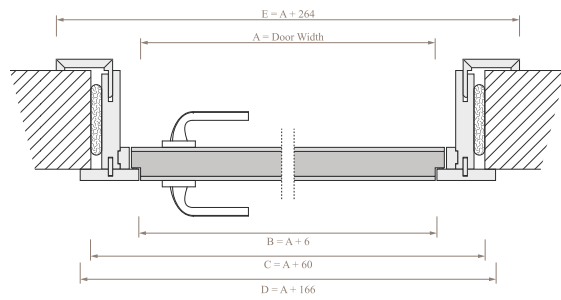

Note: The door will vary according to the design chosen on page 50.
Please confirm dimensions with our technical support before placing your order.

**MAKASSAR
COLLECTION**
3D outlines

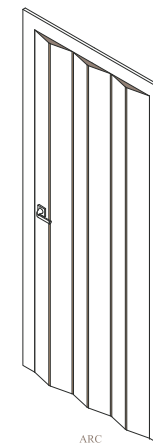
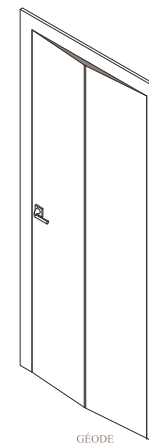
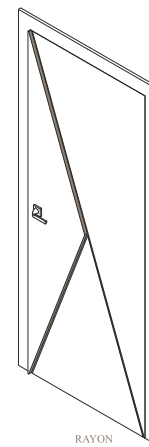
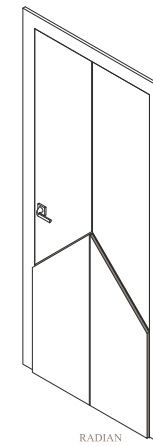
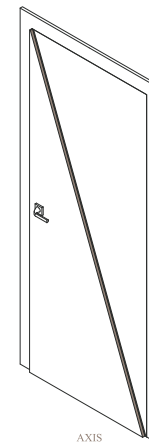
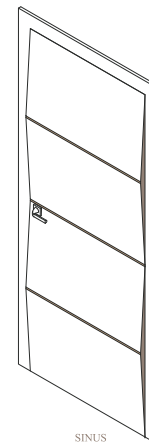

PRODUCT INFORMATION

BLACK & WHITE COLLECTION

DIMENSIONS	Height: 2000 to 2300 Width: 700 to 900. Others upon request.
DOOR	Faces with exclusive or flush design. Square edge 44mm. Hollow core / Solid core. Garnet lipping all around the perimeter of the door.
FRAME	MDF. Architraves square and butt jointed 80mm.
FINISH	Premium lacquered.
ACCESSORIES	Handle with exclusive design and finishing. Magnetic lock and invisible hinges.
OPTIONS	Sliding doors.
PERFORMANCE	Fire Door 30 min.

MAKASSAR COLLECTION

DIMENSIONS	Height: 2000 to 2300 Width: 700 to 900. Others upon request.
DOOR	Faces with volumetries and golden inlays. Similar to rebated door. Hollow core / Solid core.
FRAME	Plywood. Architraves square and butt jointed, 80mm. Door stop with rounded profile.
FINISH	Ebony Makassar.
ACCESSORIES	Golden handle with magnetic lock and invisible hinges.

CONTACT



VICAIMA, S.A.
Apartado 9,
3730-953 Vale de Cambra
PORTUGAL

T | +351 256 426 300
E | hautecouture@vicaima.com
www.vicaima.com

Veneer colours and photography are shown as a guide only. As we are constantly improving our products, we reserve the right to make changes without prior notice.

September 2012