



*Arnold Laver*

Door Set Solutions – Technical Guide

[laver.co.uk](http://laver.co.uk)



# Contents

<b>About Us</b>	<b>4</b>
<b>Our Manufacturing Processes</b>	<b>6</b>
<b>Ordering Your Door Set</b>	<b>8</b>
<b>Delivery, Handling, Storage and Installation</b>	<b>10</b>
<b>Tried and Tested</b>	<b>12</b>
<b>Sustainable and Certified</b>	<b>13</b>
<b>Arnold Laver Door Set Solutions</b>	<b>14</b>
<b>Our Ranges</b>	<b>15</b>
<b>Door Set Composition</b>	<b>16</b>
Door Cores	
Frames and Linings	
Fire Resistant Glazing	
Glazing Systems	
Vision Panel Designs	
Glazing Screens	
Seals – Fire, Acoustic and Smoke	
Door Handing	
Ironmongery and Finger Protection	
Security	
Double Swing Door System and Anti-bacterial	
<b>Let's Specify</b>	<b>37</b>
Arnold Laver Range Technical Details	
Huet Range Technical Details	
<b>Partnership Excellence</b>	<b>106</b>
<b>Finishing Touches</b>	<b>108</b>
Arnold Laver Veneers	
Formica Colours and Woods	
Huet Woods and Colours	

## About Us

Arnold Laver is focused around the following aims:

---

### Our Vision

'To help our customers to build well, using sustainable materials.'

---

### Our Mission

'To be the first-choice supplier for certified timber and timber-based products in the UK by making it easy for our customers to trade with us.'

---

## The Company

Arnold Laver is a progressive and innovative family-run business which has been in operation for almost 100 years.

A major force in the UK timber industry with a national network of fourteen Depots, we aim to provide the best timber and timber-based products available.

---

## Customers

Our customers are the heart of our business – they are the driving force behind everything we do.

---

## Staff

Our employees are the source of our strength and the foundation of our knowledge, determination and success.

---

## Products

We aim to stay at the forefront of our industry, by delivering both quality and innovation through our products. Our stock range cannot be beaten and we endeavour to support this by constantly reviewing our product offer, through research and development and the evaluation of new materials.

---

## Service

Our customers can be assured of a fast turnaround, excellent quality and a service that's unrivalled anywhere in the UK. This is made possible by our large, well-stocked and strategically located depots and our own fleet of delivery vehicles.

# It's just a door isn't it?

Doors not only need to look great, they should also perform well in their environment, whether they are in a hotel, school, shopping centre or in a home.

Our Door Set Solutions bring together the best in manufacturing capabilities and design, to deliver great looks and superb performance.

Whether you need enhanced acoustic ratings for a new cinema or high-quality fire door sets for a hotel, our range offers exceptional sound and fire proofing properties to fit any project perfectly.

And to complement your interior design requirements, our door sets can be customised from a wide selection of ironmongery and door finishes to add that wow factor.



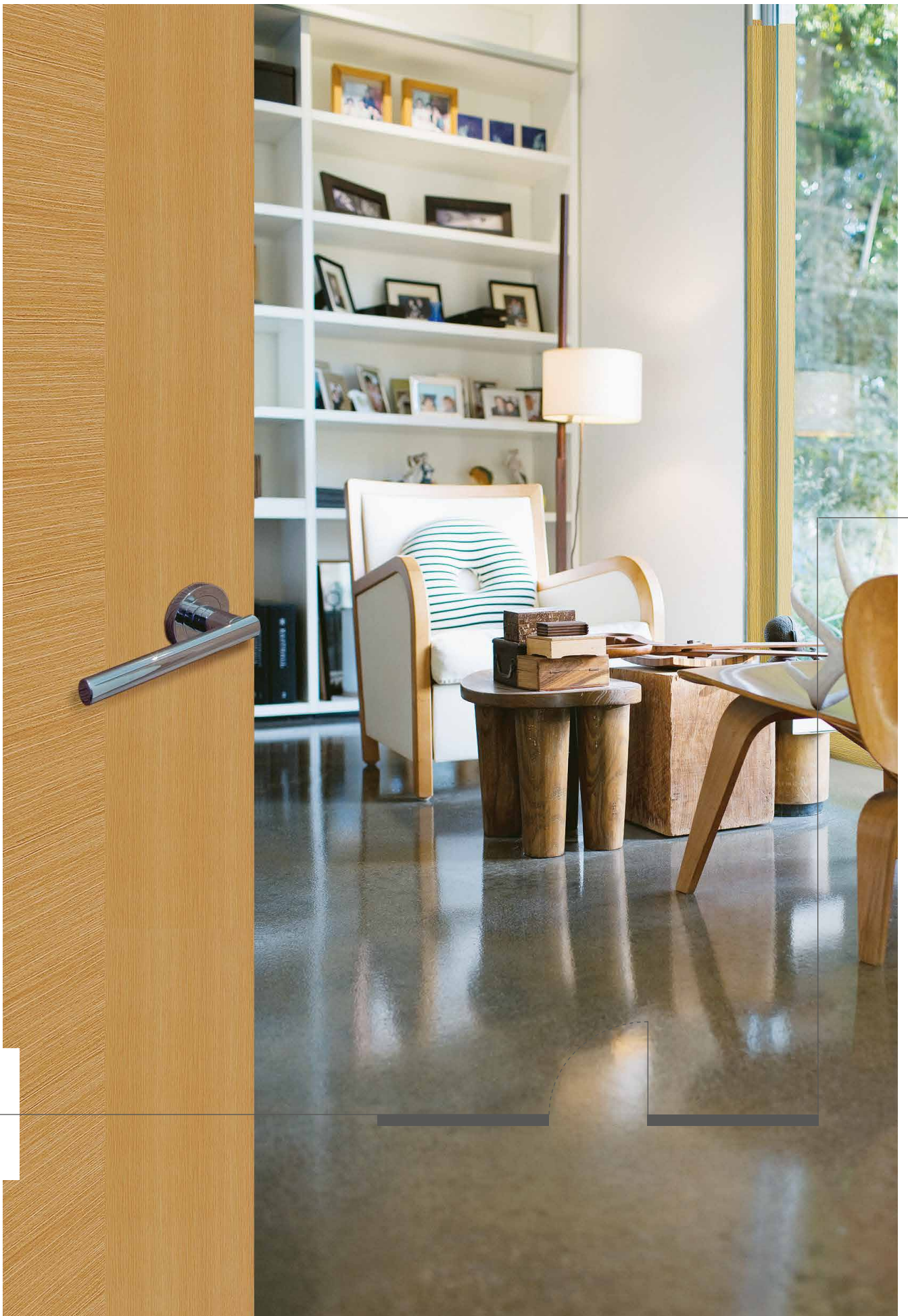

# Our Manufacturing Processes

We offer a bespoke door set manufacturing service that is designed to make installation quick and easy. With locations across the UK, our manufacturing process and materials are carefully controlled and monitored to ensure every door set produced is of the highest quality.

## Locations throughout the UK

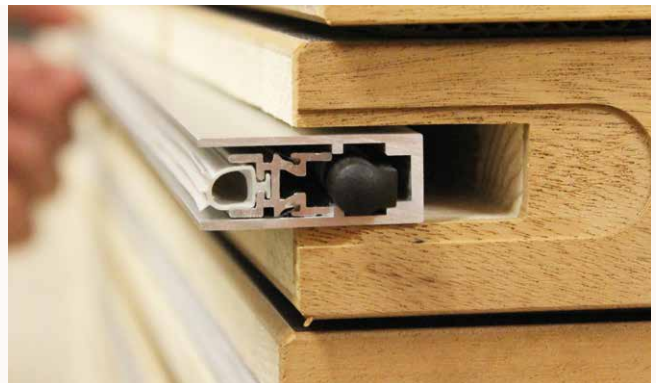

## Making the Door

The door leaf will be manufactured by using either a pre-manufactured door from a certified volume door manufacturer or in-house made from door components. The door will be finished as specified from a large range of options including painted, woodgrain veneers, laminated or bespoke pantograph designs.

The door will then be processed through the CNC machine which will router for the hinges, ironmongery and intumescent and acoustic seals as required.

Glazed fire doors will be manufactured by our specialist glazing team to ensure compliance with certification and that the appropriate fire seals and glazing systems are used.

---

## Constructing the Frame

Components are manufactured and checked for quality and density within our own sawmill facilities.

The frame will be made to the agreed specification and finish, constructed using quality components and pre-machined for ironmongery and intumescent strips as required. It will then be assembled and checked to ensure the tolerances match the certification for the door set.

Door stops are generally supplied in long lengths and cut to size and supplied loose for further positioning on site.

All door sets are fitted with Arnold Laver's hinges and seals as standard with the option of fitted handles, closers and signage.

We can also pre-machine for customer specific ironmongery templates for fitting on site, these need to comply with certification.

## Assembling the Door Set

The door leaf will be secured in the frame and tested to ensure it operates smoothly. All manufactured door sets will go to site assembled, except for pairs of doors which will be supplied in kit form.

All door sets are manufactured to industry recommendations and gaps between the door and the frame will comply with the correct specified dimensions.

Whilst every care is taken during manufacturing to set the gap tolerance, it is ultimately the responsibility of the people who fit the door set to ensure that any gaps are adjusted to maintain compliance. Typical industry guidelines for gaps between the door and the frame are 3mm around the perimeter, whilst the threshold should be no more than 8mm for fire and 3mm for fire and smoke.

---

## Meeting Standards

Our manufacturing practices and sourcing of raw materials follow the strict policies and guidelines of our ISO 9001:2015 quality management system.

All our door set ranges are tested and certified to EN 1634-1 or BS 476 standards by independent accredited bodies to meet Building Regulations.

We are also proud to be members of BWF-CERTIFIRE and BM TRADA QMark who rigorously test and accredit our door sets to ensure they comply with fire and acoustic ratings and industry standards.

---

## Unique Door Reference

The importance of third party certification is to ensure that doors are correctly labelled to maintain traceability of the product. Not only during installation but during its entire working life.

Each of our fire doors will have a label or plug fixed to it which has a unique serial number intended for that traceability. These are placed at the top of the door and recorded within our manufacturing process. This is the only method of tracking the door back to its manufacturing origin and consequently should never be removed.

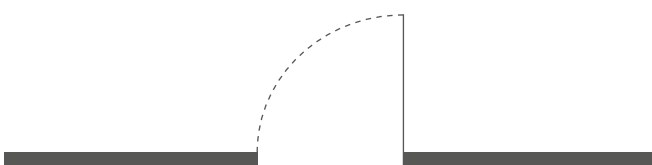



# Ordering Your Door Set

Once you have placed your order our door set support team will project manage your order with you to ensure the right products are made and delivered on time. They will monitor your order and keep you updated on progress to ensure a smooth service.

## Placing Your Order

Once we have agreed what specifications you need we can order your door sets. To get things moving quickly for you we will need a few bits of information up front:

- Your name \_\_\_\_\_
- Your company name \_\_\_\_\_
- Your email address \_\_\_\_\_
- The project name \_\_\_\_\_
- The architectural door schedule \_\_\_\_\_
- Product specifications \_\_\_\_\_
- Door elevations \_\_\_\_\_
- Door handings – left or right-hand hung \_\_\_\_\_





### How We Deliver

Veneer and laminate door sets will have protective covering placed over the door to preserve the finish. Wooden spacer batons will be fixed across the door set which should be kept in place until installation to prevent damage. This stops the door from opening in transit and creates bearers for stacking door sets, keeping the door faces apart. A stack of door sets will be shrink wrapped to a heavy-duty pallet and labelled for the correct application and location.

Any door frames sent separately for pairs of doors will be wrapped, labelled, placed on bearers and delivered with the relevant doors.

### Our Vehicles

We will deliver your door sets from our fleet of vehicles ranging from 40ft trailers to Moffett trucks depending on the size of the load, if a fork lift is required and the location of the site. If there are access restrictions or a fork lift is required to offload, please make us aware of this in advance so that we can make the necessary arrangements. Our fleet of Moffett trucks come complete with a mounted fork lift saving time on site.

### Handling & Storage

As door sets are heavy we recommend a minimum of two people handling them. They should be lifted evenly to avoid bending and stored on a flat level surface inside a dry, well ventilated area avoiding exposure to sunlight.

Any defects that are immediately visible should be written on the delivery note straight away.

Each door set should be checked upon delivery within 48 hours and any further defects or damages reported within that time. Each door set should then be repackaged to keep them protected until it is time for them to be installed.

Use load bearers equally across the doors when stacking to ensure even weight distribution and place the widest door at the bottom.

# Delivery, Handling, Storage and Installation





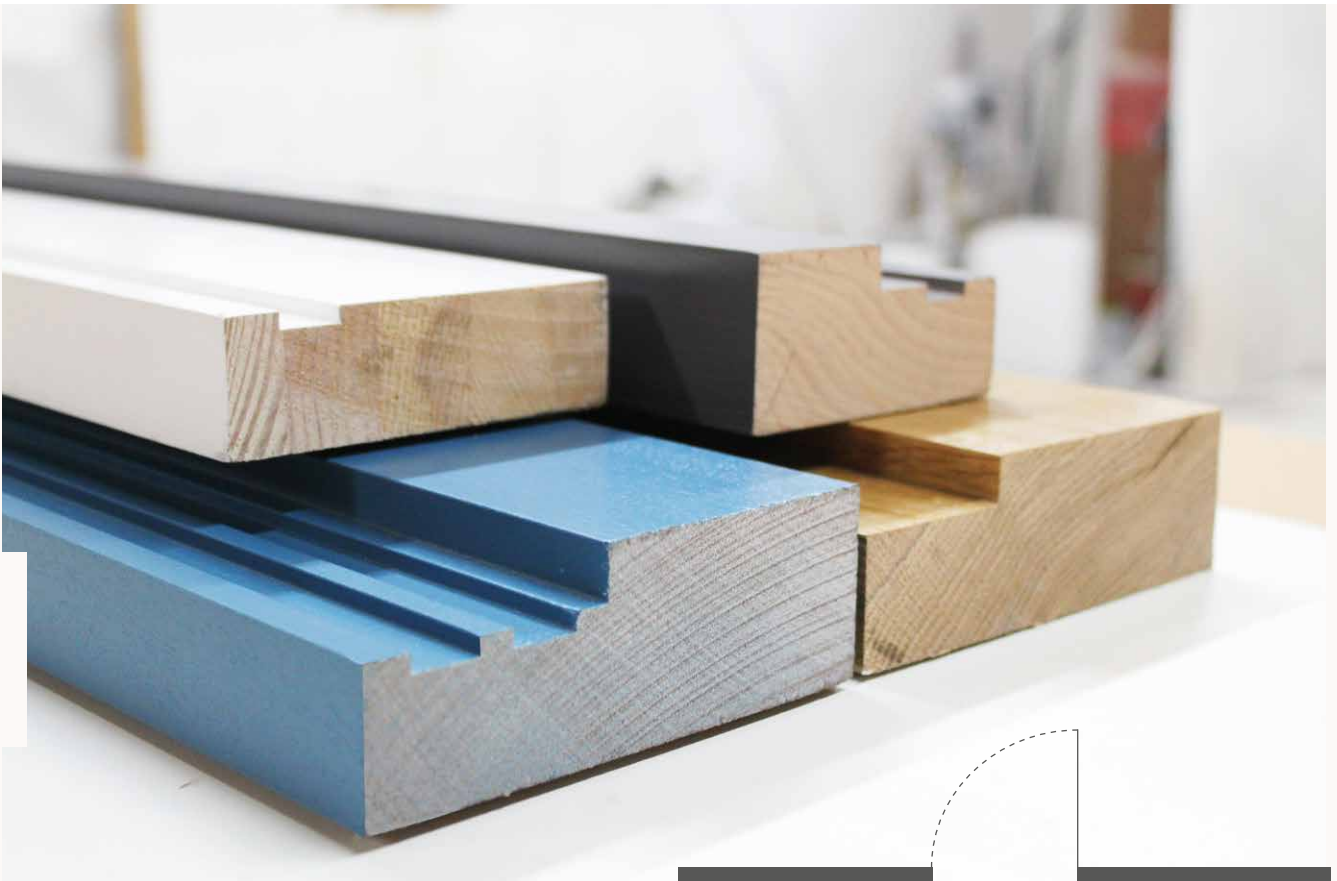

## Installation Guide

Fitting instructions will be provided with each door set to assist with the correct installation.

These are the main points to follow when fitting an Arnold Laver door set:

- Fit the door set into the opening and add packers as needed

---

- Fix hinge side first and check for straightness

---

- Fix the head to the wall and then the other side of the frame

---

- For fire rated doors follow the gap rules, 3mm around the perimeter and either 8mm on the bottom for fire or 3mm for fire and smoke

---

- Backfill the edge of the frame with approved intumescent mastic or other suitable fire material

---

- Pin the stop in place and ensure the gap left is correct. If using an Arnold Laver Batwing seal an appropriate gap must be left between the stop and the door for the seal to operate correctly

---

- Fit CE marked ironmongery to comply with door set performance and certification unless already pre-installed by Arnold Laver

---

- Intumescent fire seals will be pre-fitted in the door or frame and once installed the fire seals may be painted over. Do not paint flexible elements of combined acoustic, smoke and fire seals. Batwing seals are supplied loose for fitting on site

---

- Ensure the threshold is fitted to comply with fire certification

---

# Tried and Tested

All Arnold Laver Door Set ranges are tested and certified to ensure exacting performance and full compliance for every application that they are made for.

Our team also play a leading role in the industry, by working closely with door certification bodies to continually drive quality and safety standards for doors and other joinery products.



## 10 years Guarantee

All door sets are guaranteed for 10 years against manufacturing defects providing they are stored, fitted and maintained as recommended.



## British Standards

All door sets are manufactured in accordance with the following standards, BS4787 Pt 1 (tolerances), BS EN1634 -1 & BS 476: pt 22 fire performance.



## Acoustics

Doors will be fitted with the appropriate seals and are acoustically tested to achieve the certified passage of sound performance and to comply with BS EN ISO 10140-2: and Part E of Building Regulations.



## Fire and Smoke

All door sets are fitted with the approved intumescent fire and smoke seals and independently certified under the BWF CERTIFIRE and BM Trada QMark schemes to meet Part B of Building Regulations.



## Mobility

To comply with BS8300 and Part M of Building Regulations doors should be designed and specified using 'effective clear opening widths' to provide disabled access and movement. We offer a range of widths to comply with regulations.



## Glazing

All glazing units use toughened safety glass and are tested and fitted to meet the relevant fire and acoustic performance criteria.



## Security

All Arnold Laver door sets that provide access to a dwelling are tested to British Standard PAS24 as standard to meet Part Q of Building Regulations. We also offer Secured by Design (SBD) third party certification.



## Seals

Intumescent fire and smoke seals are essential to the door set performance so are durability tested to up to 10 times the industry standard to resist fire under conditions of BS 476-22: 1987, BS EN 1634 -1: 2014 and smoke conditions of BS 476-31:1 1983; BS EN 1634-3: 2004. Acoustic seals are fully tested as stated within BS EN 10140-2: 2010 rated in accordance with ISO 717-1: 2013.



## Durability

Our door sets are tested to meet the requirements of EN1192 for strength and EN12400 for mechanical durability.



## Integrated Management Systems Certified

Our manufacturing processes are strictly managed under the guidelines of our ISO9001, ISO 14001 and BSOHSHS18001 policies and procedures.



## Sustainability

Our door set materials are sourced from responsibly managed forests and carry either Forest Stewardship Council® (FSC®) or PEFC chain of custody certification.

# Sustainable and Certified

We work with a range of third parties to certify our products and ensure we remain up-to-date with the latest industry accreditations and trends.

We work closely with various industry door schemes including BWF-CERTIFIRE and BM TRADA, to ensure all our fire and acoustic door sets adhere to the required specifications and regulations. We also ensure any third-party sourcing for components such as ironmongery, hinges and seals are of the highest standard and tested to meet the relevant certification.

## Sustainable Sourcing

We value our green credentials and believe strongly that it is our corporate and social responsibility to preserve the world's forests and promote effective forestry management. We do this by ensuring our products are sourced from legal, sustainable and well managed forests and mills.

Our door sets carry Forest Stewardship Council® (FSC®) or PEFC chain of custody certification that is independently evaluated, certified and available upon request.

## Door certification



## Industry accreditations



## Environmental certifications

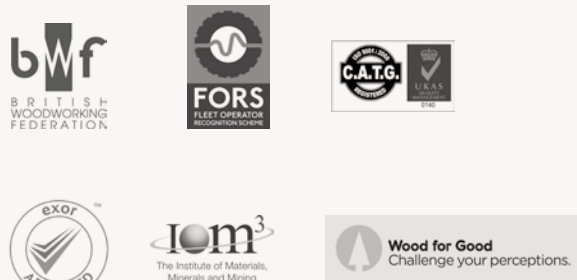

**Innovation is in our DNA**

From multi-core door leaves with revolutionary acoustic properties, to anti-bacterial door finishes for medical use - research and development is a fundamental part of everything we do. It's part of our corporate DNA.

**Non-Fire and Fire Door Sets**

We can offer non-fire rated and fire rated door sets from FD30 to FD120 with the capability of being a smoke controlled or self-closing door. Our range are made from timber leaves and a choice of timber or metal frames. For public buildings we offer a range of single and double leaf options (pair) that can be single acting or swinging, ideal for busy areas and corridors. The swinging systems offer some of the most state-of-the-art mechanics for holding, locking and closing in the market.

**Acoustic Door Sets**

Thanks to an expertise developed over 65 years, we can supply a high-performance range of door sets with some of the thinnest door leaves available. With a choice of ratings from 29 Rw dB to 55 Rw dB, we have a product to match any requirement.

**Technical Support**

Our team of technical managers will work with you to understand your specific project and design considerations to ensure the right door is specified for each application. They will advise you on the various design options available to you to meet your desired outcome, whilst achieving the relevant standards and regulations.

**Industry Standards**

Our technical team continually assess and test our products to ensure we continue to deliver quality, performance and reliability that will exceed standards.

All door sets are tested and certified to EN 1634-1 and BS 476 standards by independent accredited bodies to meet Building Regulations.

# Arnold Laver Door Set Solutions

**Great Looks, Superb Performance**

We know that one size doesn't fit all. That's why we offer an extensive range of high performance door set solutions to fit virtually every application.

Our team of door set technical experts are on hand to help you specify the right doors to fit each aspect of your project, giving you confidence that fire, smoke, acoustic, durability, security and radiation performance will be met, and the end result will be impressive.

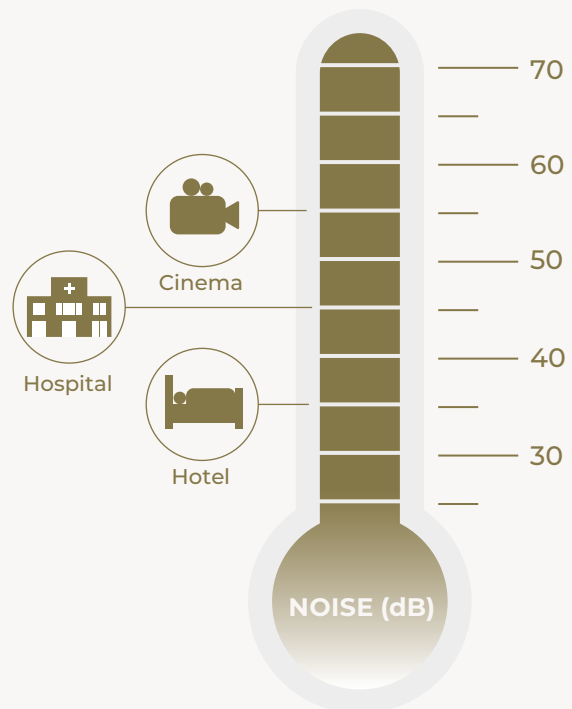

# Our Ranges

1

## Standard

- Standard door set sizes
- Basic fire and acoustic ratings
- Off the shelf product
- Faster lead times
- Standard range of vision panel

2

## Bespoke

- Made to order door sets
- Manufactured in house to specification
- Tailored fire and acoustic performance ratings
- Tailor made range of vision panels

3

## Advanced

- Advanced acoustic and fire properties
- Improved durability
- Specialist door sets

4

## Frames and Screens

- Standard, fire and acoustic rated screens to fit specification
- Made to order

# Designed to Impress

A huge amount of research and development has resulted in creating a first-class range of door sets that operate beautifully within their specific surroundings.

Each component has been specially designed to work together to deliver outstanding results.

The main components of the door set are:

- Door
- Frame
- Seals
- Glazing
- Ironmongery

How the door will be used, and the proposed location will determine the overall composition required.

Our highly experienced technical team will work with you to understand your requirements in detail and recommend the appropriate options available from our range.



- 1- Sealing for back of frame
- 2- Ironmongery
- 3- Frame
- 4- Glazing systems
- 5- Door leaf
- 6- Air transfer grill
- 7- Threshold seal
- 8- Fire seals or fire & smoke seals (perimeter)



### Inside the Door

Ever wondered what was inside a door and why one door 'clunked' harder than another? It's because each door has a core which will vary depending on how it will be used, and the performance measures it needs to achieve.

Arnold Laver door sets have a range of cores to meet different specifications.

### Standard Range

The Standard Range comes in standard sizes with softwood stiles and a choice of cores – from hollow core which is light weight, generally used in residential properties, to heavy duty used in communal or commercial environments.

The thickness of the door ranges from 35mm for standard openings to 54mm where a 60-minute fire door (FD60) is a necessity. Fire cores have a solid, high-density core which is fire tested and certified to meet the relevant application.



**Hollow Core**  
35-40-44mm\*



**Solid Core**  
35-40mm



**Solid Core**  
44mm FD30



**Heavy Duty Core (HDC)**  
44mm FD30



**Solid Core**  
54mm FD60

\*44mm double top and bottom rail

## Bespoke and Advanced Ranges

These ranges have different core construction that can be made to order and are composed of 3-layer particle board with various fire ratings. The heavy duty range provide extra strength and the option of feature grooves and panel designs.



**Solid Core**  
44mm FD30

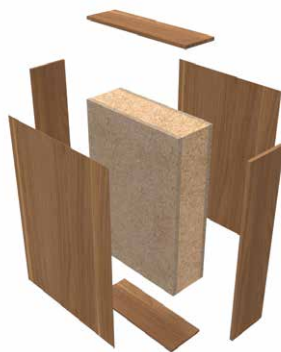

**Solid Core**  
54mm FD60



**Heavy Duty Core**  
(HDC) 44mm FD30



**Heavy Duty Core**  
(HDC) 54mm FD60

Huet have a range of composite cores to meet specific requirements.

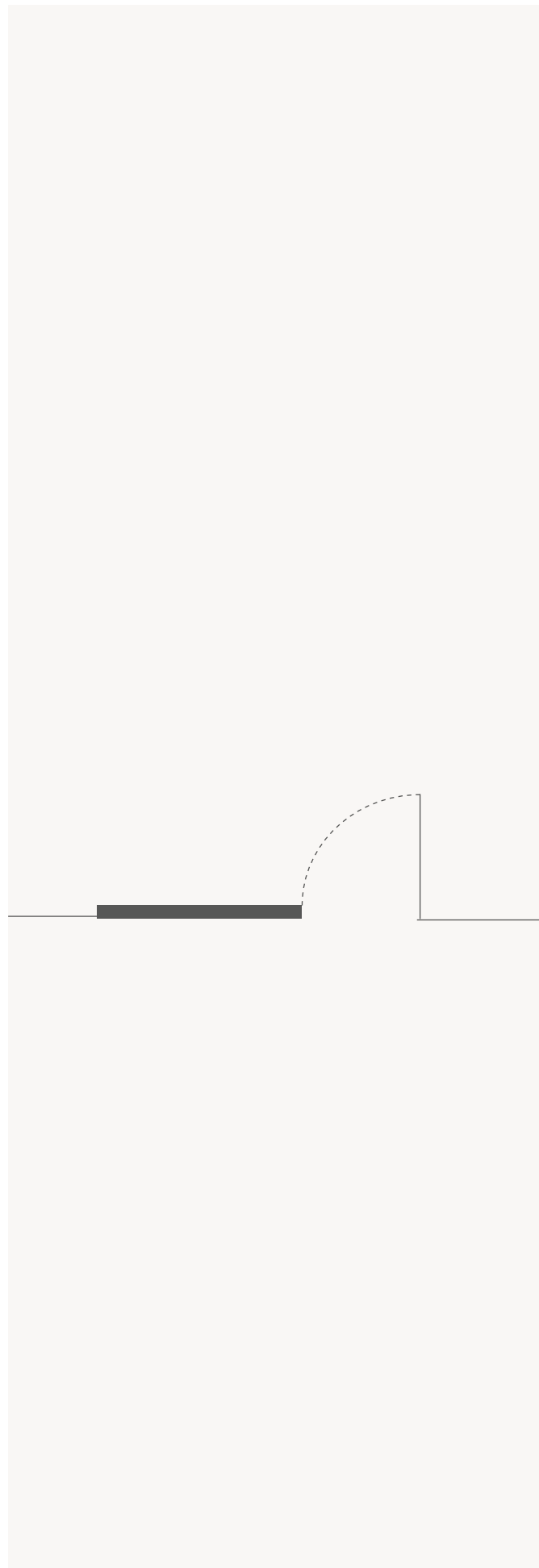



## Framing the Door

The door frame is equally as important as the door core in guaranteeing that the door set will meet the relevant performance standards.

The material for the frame will vary depending on what level of fire protection is required. Often a softwood frame is used for FD30 fire doors and hardwood for FD60 but our technical team will work with you to ensure the correct frames are specified for the situation they are being made for.

We offer a range of door lining and rebated frame sizes which make up the frame, with 30 and 60-minute fire protection options to meet UK standards.

### Door Linings

Our standard door lining profile is 32mm with a 12 x 36mm stop-lath. If you are using a concealed overhead door closer you may need a larger rebate or stop-lath which can be arranged.

The UK manufactured linings come flat packed ready to be built on site or pre-assembled with a loose stop-lath.

### Rebated Frames

Our standard profile is 44mm thick with a 12mm rebate and a grooved recess for intumescent strips depending on the fire specification.

The door frame is supplied with a 25mm extension to the legs as standard and will need reducing to suit your individual floor finish. Please note to comply with our third party certification the maximum gap between floor finish and door will be 3mm for smoke and 8mm for fire.

We can provide frames unfinished, primed, lacquered, stained and painted.

# Fire Resistant Glazing

Glazing has a major impact on fire performance – the aperture shape and position, and style of bead and glass – are all major influencers.

Therefore, when forming a glazed aperture in a fire resistant door or wall it's essential that correct fire resistant glass is installed.

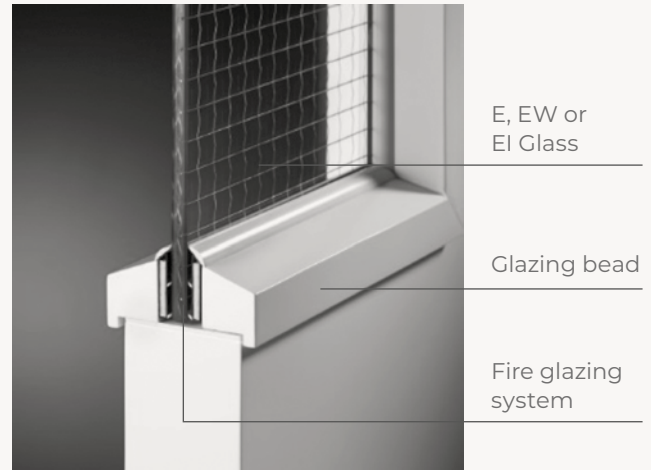

## Choosing the Right Glass

There are three main fire related threats to consider when choosing glass for an application.

### **Smoke** –

is one of the main causes of fire deaths and obscures visibility which impacts on seeing escape routes if a fire breaks out.

### **Flames** –

will cause the fire to spread which will destroy property and potentially cause fatal injuries.

### **Radiated Heat** –

causes the spread of fire through combustible materials.



## Insulation and Integrity

There are various glazing options which, when combined with the appropriate glazing system, will provide a solution to combat smoke, flames and radiated heat. These are classified as E, EW and EI.



### **E Class – Integrity Only**

Glass that meets these criteria will stop the spread of flames and hot gases, but it will not stop the spread of radiated heat transferring through the glass. This can cause materials on the non-fire side to combust when it reaches a high temperature.



### **EW Class – Integrity and Radiated Heat Control**

Glass in this category will stop flames and smoke and reduce the level of radiated heat to no more than 15kWm<sup>2</sup> from a metre distance.



### **EI Class – Integrity and Insulation**

This glass offers the highest level of protection stopping flames, smoke and radiated heat. An interlayer between the glass panes foams up in the event of a fire which protects and cools the glass and provides an opaque barrier.



### **Impact Resistant**

Glass which meets this category has some form of safety function to protect against injury or impact with glass and is categorised for its impact resistance within BS EN 12600 and BS 6206, and in addition to classification BS EN 12600 (in order of highest performance are: Class 1B1, Class 2B2 and Class 3B3).

## Fire Glazing Components

The glazing cassette comprises of the fire resistant glass, a fire glazing system and the glazing bead.

The fire resistant glazing system holds the glass firmly in place during normal use, but in the event of fire the intumescent material expands, securing and insulating the glass and protecting the surrounding timber.



**30-minute fire-glazed door in normal 'cold' conditions**



**30-minute operating in normal 'hot' conditions**



**60-minute fire-glazed door in normal 'cold' conditions**



**60-minute operating normal 'hot' conditions**

We provide glazed fire door sets and screens which provide fire resistance from 30 minutes up to 120 minutes. These are fully tested and certified to meet requirements.



## Fire Glazing Systems

We use a variety of fire certified glazing systems to meet the required specification and fire door ratings. Listed below are the most common ones used based on the typical performance criteria required. These are all independently tested and accredited under the BWF-CERTIFIRE scheme.

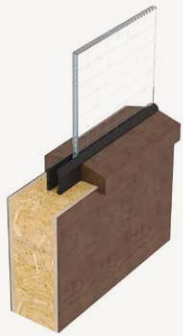

### FF1

Designed for use with glazed apertures in 30-minute fire resistant doors.

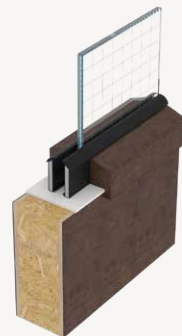

### RF1™

A versatile glazing system for 60-minute fire resistant doors and screens.

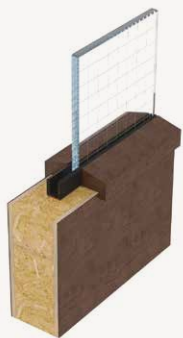

### System-36 Plus

This is a flexible U-shaped glazing gasket designed for 30 and 60-minute fire resistant doors and screens.

- Can fit glass thickness from 5mm to 23mm
- Flexible enough to be fitted to curved corners and circular vision panels

Huet door sets use their own certified fire glazing system.

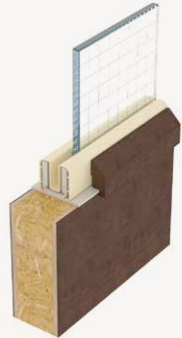

### System-90 Plus

Designed for 60, 90 and 120-minute fire resistant doors and screens.

- U-shaped PVC profile containing an intumescent core and liner

## Glazing Beads



**Bolection Bead**



**Flush Bead**

Glazing beads are required on both sides of the glass and will be aesthetically finished to match the door. We can provide a variety of bolection beads or a flush bead depending on design requirements. The flush bead provides cleaner sight lines whilst a bolection bead offers a more traditional look suitable for all applications apart from sliding doors.

## Vision Panel Designs

Glazing designs improve safety in busy environments because of the ability to see through them as well as offering improved design attributes. The panel design choice will depend on the performance requirements of the door set. Our technical team will assist you to explain the options and ensure the correct glazing is specified.

We have included our most commonly specified glazed fire door designs offering 30 and 60 minute fire ratings but can offer others upon request.

We can offer clear, obscure and manifestation designs of glass for fire and non-fire glazed doors.

Huet use their own fire glazing cassettes to meet UK standards, and their vision panel designs are highlighted on pages 68–107 in the technical section.



**AL 54**

**AL 01**

	<b>Non-fire</b>	<b>FD30</b>	<b>FD60</b>
	Clear	Pyrodur® 7mm	Pyrodur® 10mm
<b>AL 54</b>	✓	✓	✓
<b>AL 01</b>	✓	✓	✓
<b>AL 56</b>	✓	✓	✓
<b>AL 63</b>	✓	✓	✓
<b>AL 38</b>	✓	✓	✓
<b>AL 37</b>	✓	✓	✓
<b>AL 16</b>	✓	✓	×



**AL 56**



**AL 63**



**AL 38**



**AL 37**



**AL 16**

## Glazing Screens

Why not add some full glazed side screens with your doors to lighten up a dark hallway?

We can offer a wide range of 30-minute and 60-minute fire rated screens and walls to complement your door designs or create airy work spaces. We can also offer a range of acoustic screens and walls to achieve 29dB and 50dB.

Our vision panels are manufactured from high performance hardwood timber suitable for any residential or commercial application.

All glazing is fully tested and certified to meet fire regulations.

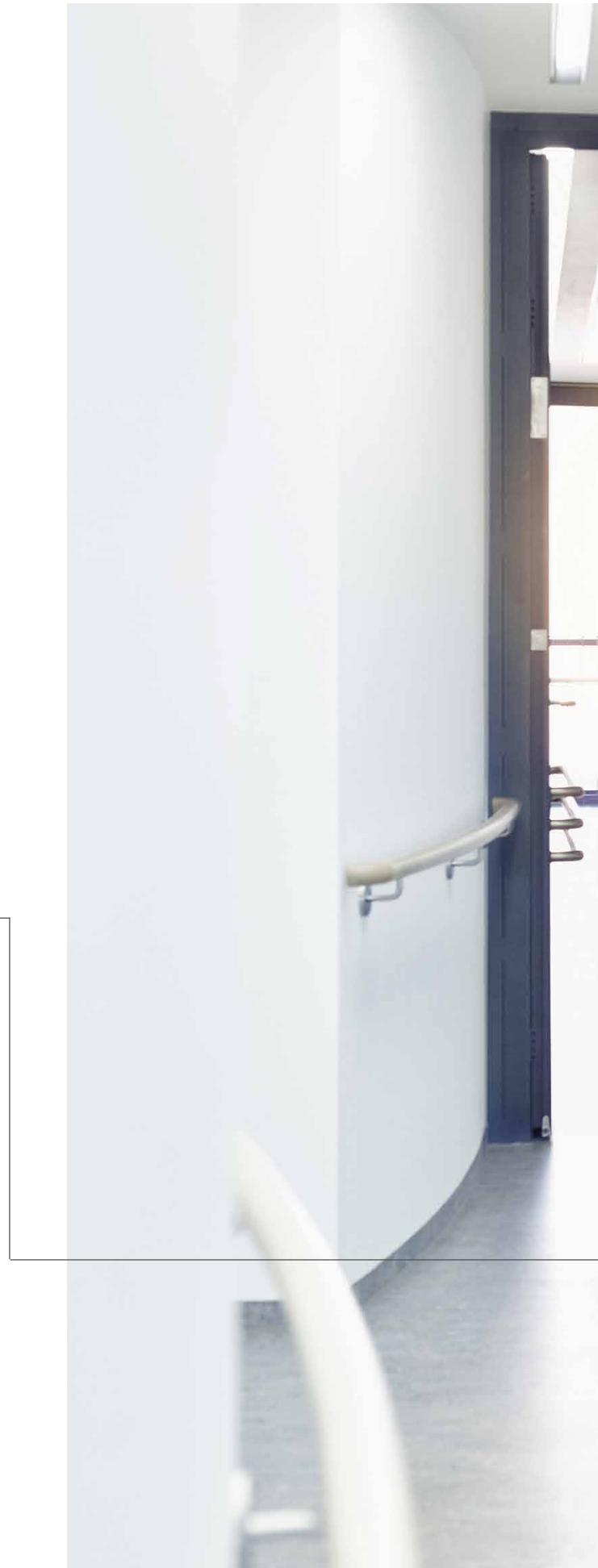



# Safe and Sound

## Seals

To achieve excellent safety and acoustic performance we utilise some of the best performing seals and ironmongery in the market. We have illustrated some of our most popular seals and how they operate to provide guidance when considering containment of sound, smoke and fire. We also offer a range of PAS24 and Secured by Design fully tested doors to fit projects that need additional security.

Gaps around the four sides of a fire door leaf are essential – it's the only way the door can open and close. But these gaps create a point of weakness, where fire can take hold and destroy the door and lethal smoke can pass through. In everyday use sound can also pass through unprotected gaps, and the building's heat can be lost.

Intumescent seals are fitted into the head and jambs of the door frame or into the top and sides of the door leaf itself. In the event of fire, intumescent seals expand to 5 – 10 times their original size sealing the gaps around the door and providing an effective barrier to fire and hot smoke.

Seals designed for the gap between the door and frame or the gap between a pair of doors are termed perimeter seals. Seals designed for the gap between the bottom of the door and floor are termed threshold seals.

All our seals are sourced from reputable, industry leading organisations who produce the highest quality sealing systems that incorporate acoustic, smoke, fire and thermal containment, as well as accessibility.

The images included represent some of the popular seals that are used in our door sets that are tested and approved to meet industry standards.

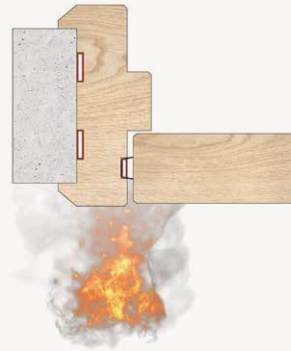

### Expanding Seal

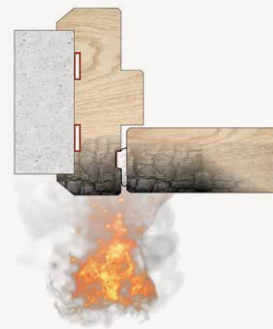

### Expanded Seal



### Intumescent Fire Seal

Our intumescent fire door seals offer the ultimate in fire protection where no smoke sealing is required.





### **Batwing® Acoustic and Smoke Seal**

The Batwing® acoustic and smoke seal offers excellent acoustic performance owing to its unique curved fins which are always in contact with the door face and door edge. The flexible elastomeric fins spring back to their original shape to provide ongoing performance and durability.



### **Acoustic, Smoke and Fire Seal**

Our DS door seal offers the ultimate in acoustic, smoke and fire protection with the added benefit of thermal containment. Its unique design means that whichever way round the product is installed, the seal can always be fitted in the correct place, maintaining the integrity of the acoustic and smoke seal at the ironmongery points. The seal also includes integral antimicrobial protection.



### **Intumescent Fire and Smoke Seal**

Our fire and smoke seals offer maximum protection with the added benefit of thermal containment. The seal also includes integral antimicrobial protection.



### **Drop Seal**

Drop seals are fitted at the bottom of the door to close the gap with the floor when the door closes using a mechanical system. This is useful for acoustic and smoke control particularly where disabled access is required.

We offer a choice of automatic, concealed and face-fixed drop seals suitable for use with fire rated doors. These seals lift clear of the floor as soon as the door is opened by a few millimetres. The most effective acoustic system teams a drop seal or door bottom with a threshold plate.

## Seal Colour Range

### Standard Colours

All our intumescent seals are available in a standard range of colours, some of which have been selected to harmonise with commonly specified timbers.

The Batwing® and DS seals are normally supplied with black brushes or fins; white fins are also available.

### Special Colours

We also offer many special finishes and a precise colour matching service.

### Metallic Finishes

Satin Anodised Aluminium (M203)

Bright Polished Chrome (M403)

Satin Stainless Steel (M404)



**White** (0303)



**Cream** (1047)



**Maple** (1740)



**Gold** (0502)



**Bronze** (0501)



**Copper** (0503)



**Red** (3073)

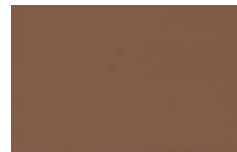

**Light Brown** (8018)



**Dark Brown** (8004)



**Silver** (0701)



**Grey** (D838)



**Black** (0001)

### Woodgrain Finishes

Many seals are available with a woodgrain or metallic finish. Both finishes are achieved by laminating special polyester films directly onto the PVC casing of the seal.

Be aware that timber darkens with age and can change colour significantly when polishes and other clear finishes are applied.

Note: The limitations of the printing process mean the colours and finishes shown here may not be exactly the same as the seals supplied. We can supply free samples to assist colour matching.



**American Sycamore** (W402)



**Limed Oak** (W532)



**Beech** (W046)



**Ash** (W047)



**American White Oak** (W502)



**Medium Oak** (W512)

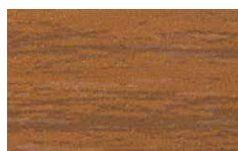

**European Walnut** (W018)

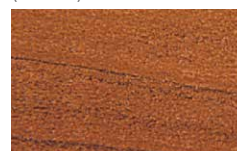

**American Cherry** (W552)

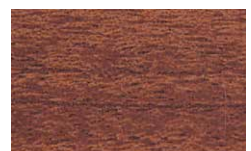

**Sapele** (W501)



**Teak** (W522)

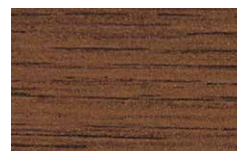

**American Black Walnut** (W804)

Right hand

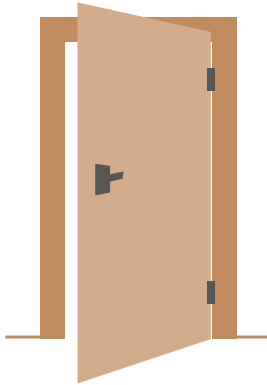

Left hand

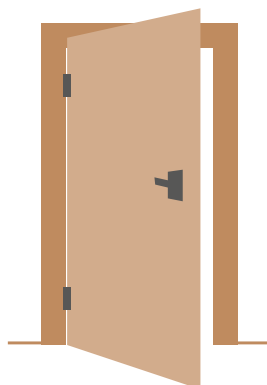

## Door Handing

Door handing is determined by viewing the door from its opening face. If the hinges are on the left-hand side, you need a left-hand hung door set. If the hinges are on the right-hand side, you need a right-handed door set. Please take care when specifying the handing of door sets to ensure they operate correctly when installed.



## Ironmongery

Our outstanding range of architectural ironmongery is available in both traditional and contemporary designs to meet even the most discerning tastes.

As well as the need for visually complementing the environment that they operate in, fire door ironmongery also plays a key role in the overall safety and security of the door.

We provide a complete solution for hinges, closers, locking mechanisms, handles and accessories such as kick plates, signs and door stops. All fire door hardware is fully certified to meet industry standards.

We can also create templates for you to use your own suitable certified ironmongery.



**Typical Retrofit Finger Guard**

**Finger Protection**

We offer a range of door sets which employ anti finger trap systems, developed specifically for schools, nurseries, hotels and paediatric wards – in fact any building used by young children.

Choose from a range of face fixed finger guards which covers both door and frame which are supplied loose for retrofitting on site – all suitable for stopping the trapping of small fingers

We can also provide an innovative smart system which incorporates a profiled timber frame and Sathys® technical hinges made from titanium-anodised aluminium which uses an axial motion. This can be complemented by an integrated deadbolt doorstop system which prevents complete closure of the doors on non-fire rated doors.

Our full range has options of FD30 and FD60 fire ratings and a large array of finishes to bring safety and fun together in the same room.



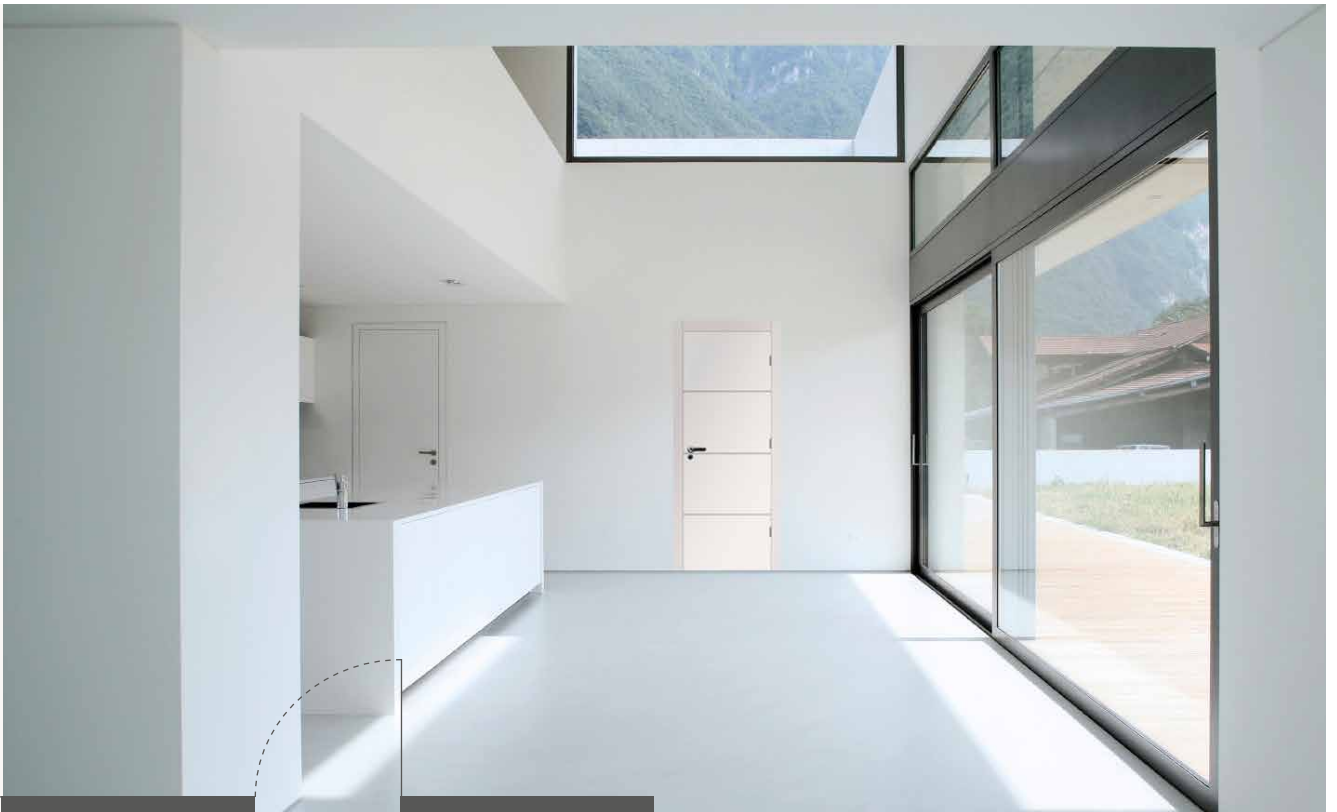

## Security

### PAS24

PAS 24:2016 is a Product Assessment Specification and a primary reference in the Building Regulations Approved Document Q1. The standard specifies test methods and acceptance criteria relevant to the enhanced security performance of door sets intended to resist methods of attack by a burglar.

The door set is tested for manual manipulation and body impact and PAS 24 also specifies requirements for cylinders, letter plates and glazing material.

### Secured by Design

Secured by Design (SBD) is the official UK Police flagship initiative supporting the principles of 'designing out crime'. It focuses on crime prevention of homes and commercial premises and promotes the use of security standards for a wide range of applications and products.

SBD doors incorporate a shielded door and frame, hinges and anti-intrusion bolts, and a 3-point locking system ideal for use in apartments and other multi-occupancy dwellings.

Our range of PAS24 and Secured by Design high security door sets are United Kingdom Accreditation Service (UKAS) tested to meet improved safety standards.

## Double Swing Door System

Our swinging systems offer some of the most state-of-the-art mechanics for holding, locking and closing in the UK today.

They are provided with a choice innovative of features:

- Holding mechanism linked directly to the fire detection system.

---

- Locking mechanism configured to keep doors open but also with the option to keep them closed using a choice of access controls.

---

- Door closer mechanism using a pivot that is placed in the upper crosspiece, offering not only a greater level of hygiene control but also aiding installation and improving robustness in-situ.

---

### Anti-bacterial

Our range of anti-bacterial door sets have a proactive additive applied to the door finish and ironmongery which destroys organic compounds such as bacteria, viruses and salmonella – perfect for health care environments.











## Let's Specify

We have included specification details and drawings for our most popular designs taken from our Standard, Bespoke and Advanced ranges, manufactured by Arnold Laver and Huet. These provide an extensive choice of performance and aesthetics encompassing fire, acoustics, security, glazing designs and ironmongery. For those important finishing touches you can find a broad selection on pages 108– 117.

We can also provide tailor made door set specifications to meet your individual requirements. Please get in touch to discuss your project in more detail.



# ARNOLD LAVER DOOR SET RANGES

## Fire and Non-Fire

	Number of Leafs	Wood Frame	MDF Frame	Smoke Seals	Fire Rating	Vision Panel	Leaf Thickness (mm)	Max Leaf Height (mm)	Max Leaf Width (mm)
<b>NON-FIRE</b>	1	●	●			●	44	2700 (at 926 wide)	1200 (at 2040 wide)
	2	●	●			●	44	2700 (at 926 wide)	1200 (at 2040 high)
<b>FD30 FIRE AND SMOKE</b>	1	●	●	●	FD30(S)	●	44	*2516 (at 926 wide)	*1142 (at 2040 high)
	2	●	●	●	FD30(S)	●	44	2244 (at 926 wide)	1019 (at 2040 high)
<b>FD30 FIRE AND SMOKE DOUBLE SWING</b>	1	●		●	FD30	●	44	2509 (at 926 wide)	1121 (at 2040 high)
	2	●		●	FD30	●	44	2244 (at 928 wide)	1018 (at 2040 high)
<b>FD60 FIRE AND SMOKE</b>	1	●		●	FD60(S)	●	54	**2305 (at 915 wide)	**988 (at 2135 high)
	2	●		●	FD60(S)	●	54	2246 (at 826 wide)	908 (at 2042 high)

## Acoustic

	Number of Leafs	Acoustic Rating (Rw dB)	Wood Frame	MDF Frame	Smoke Seals	Vision Panel	Fire Rating	Leaf Thickness (mm)	Leaf Height (mm)	Leaf Width (mm)
<b>NON-FIRE ACOUSTIC 27 - 31</b>	1	31dB	●	●	●	●		44	2700 (at 926 wide)	1200 (at 2040 wide)
<b>NON-FIRE ACOUSTIC 33 - 35</b>	1	35dB	●	●	●	●		54	**2305 (at 915 wide)	**988 (at 2135 high)
<b>FD30 ACOUSTIC 29 - 32</b>	1	32dB	●	●	●	●	FD30(S)	44	2700 (at 926 wide)	1200 (at 2040 high)
<b>FD30 ACOUSTIC 35 - Glazed only</b>	1	35dB	●	●	●	●	FD30(S)	44	2800 (at 915 wide)	1200 (at 2135 high)
<b>FD60 ACOUSTIC 33 - 35</b>	1	35dB	●		●	●	FD60(S)	54	2486 (at 1100 wide)	1192 (at 2300 high)
<b>FD60 ACOUSTIC 36 - Glazed only</b>	1	36dB	●		●	●	FD60(S)	54	2486 (at 1100 wide)	1192 (at 2300 high)
	2	36dB	●		●	●	FD60(S)	54	2300 (at 900 wide)	975 (at 2150 high)

All acoustic performances indicated are based on a small number of our product range and other products can be supplied to meet your required acoustic performance. (Contact our technical team for more information).



## Security

		Wood Frame	Smoke Seals	Vision Panel	Fire Rating	Leaf Thickness (mm)	Max Leaf Height (mm)	Max Leaf Width (mm)
<b>FD 30 FIRE &amp; SECURITY SINGLE</b>	1	●	●	●	FD30(S)	44	2300	926
<b>FD 30 FIRE &amp; SECURITY DOUBLE</b>	2	●	●	●	FD30(S)	54	2800	1050

## Screens

Screens can be supplied to meet both fire and acoustic performance and manufactured in accordance with certification of the glass and glazing systems required to achieve each configuration.

	FD30	FD60	Acoustic
<b>NON-FIRE</b>			●
<b>FIRE</b>	●	●	●
<b>ACOUSTIC</b>	●	●	●

\* All sizes indicated are achieved incorporating a latch. Should an unlatched door be required sizes will vary.

\*\* Size indicated are based on timber frames. Sizes may vary depending on MDF and metal frame requirements.

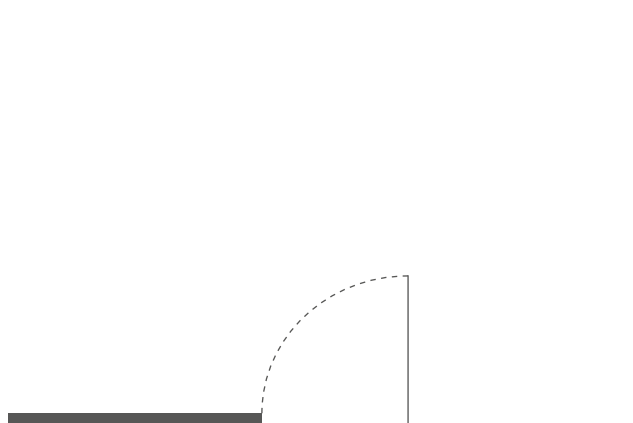

### Timber Fire-rated Door Sets

# NON-FIRE

(Single and Double Leaf)

#### Door Leaf

- Arnold Laver high density flaxboard core complete with European whitewood stiles and rails (door facing supplied in either MDF, chipboard, hardwood)
- Thickness 44mm
- Door core construction can vary pending on project requirements
- Doors can incorporate an over panel to meet project requirements

#### Door Frame

- Available in the following materials:
  - MDF
  - Softwood (solid or engineered)
  - Hardwood
- Available in the following profiles:
  - Plain lining and loose stop
  - Rebated frame (casing)

#### Choice of Door Facings

- Primed only for site finish
- Veneers – crown cut as standard, specials upon request
- Laminate
- Acrovyn (PVC)

#### Ironmongery

- Supplied with either lift-off or butt hinge as standard
- Doors can incorporate CE marked or certified approved hardware subject to compatibility with the door blank

#### Perimeter Seals

- Privacy seal can be applied on meeting stiles upon request

All door sets and door kits comply with Technical Schedule TS10.

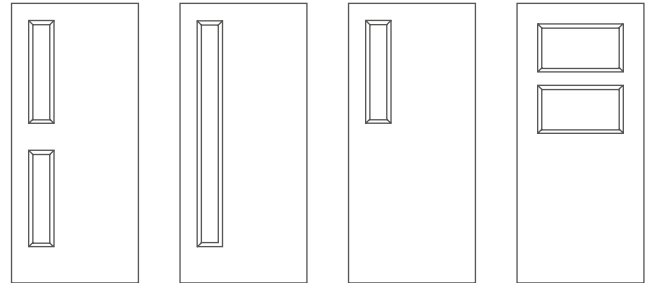

AL54

AL01

AL56

AL63

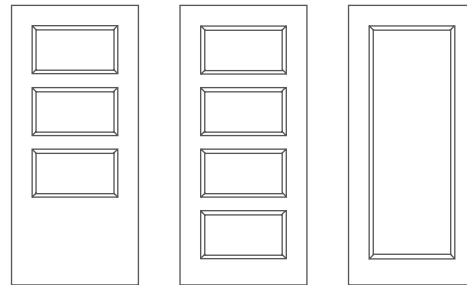

AL38

AL37

AL16

These are our most commonly specified glazed designs, others are available upon request.

Single and Double Leaf Technical Details

All sizes are in mm

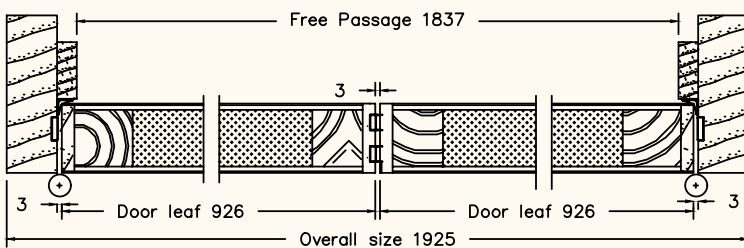
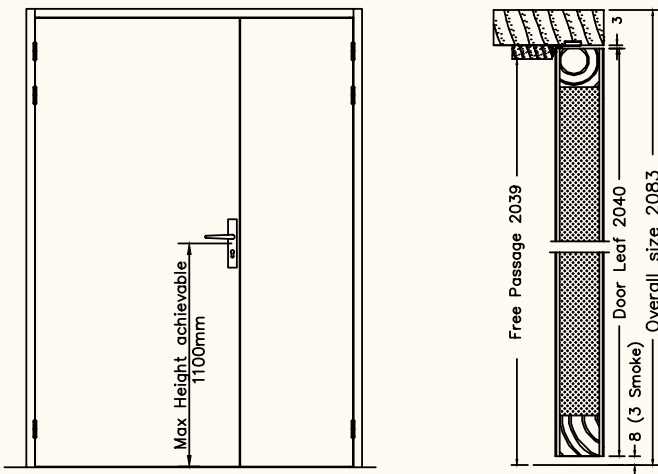
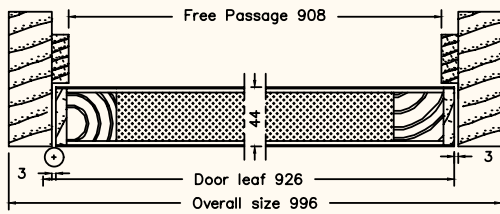
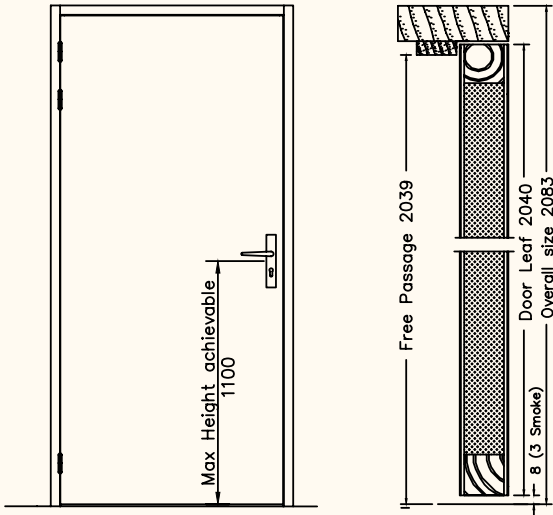

Meeting stiles available

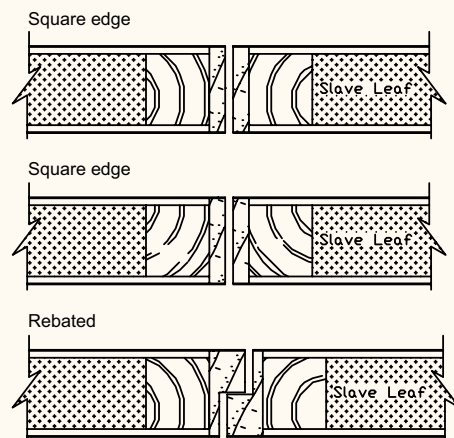

### Timber Fire-rated Door Sets

# FD30 FIRE AND SMOKE

(Single and Double Leaf)

#### Door Leaf

- Arnold Laver high density flaxboard core complete with European whitewood stiles and rails (door facing supplied in either MDF, chipboard, hardwood)
- Thickness 44mm
- Door core construction can vary pending on project requirements
- Doors can incorporate an over panel to meet project requirements

#### Door Frame

- Available in the following materials:
  - MDF
  - Softwood (solid or engineered)
  - Hardwood
- Available in the following profiles:
  - Plain lining and loose stop
  - Rebated frame (casing)

#### Choice of Door Facings

- Primed only for site finish
- Veneers – crown cut as standard, specials upon request
- Laminate
- Acrovyn (PVC)

#### Ironmongery

- Supplied with either lift-off or butt hinge as standard
- Optional drop seal
- Doors can incorporate CE marked or certified approved hardware subject to compatibility with the door blank

#### Perimeter Seal Options

- Fire only
- Combined fire and smoke
- Separate fire and smoke
- It is recommended that all intumescent seals are factory fitted as standard

#### Features



### FD30

Fire tested and certified providing fire resistance of 30 minutes integrity as defined in BS 476: Part 22.



### Smoke Seal

Appropriate integral smoke seals can be applied to restrict smoke leakage as defined in BS 476: Part 31.1: 1983 and Appendix B of approved Document B.

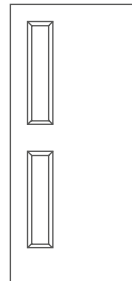

AL54

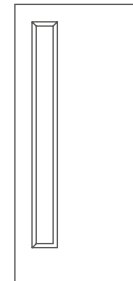

AL01

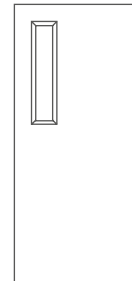

AL56

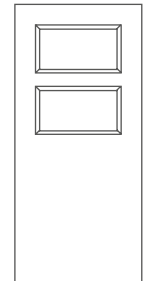

AL63

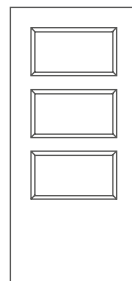

AL38

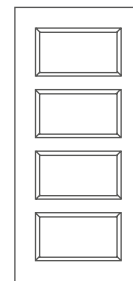

AL37

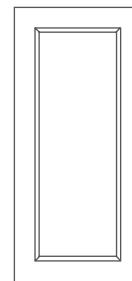

AL16

These are our most commonly specified glazed designs, others are available upon request.

Single and Double Leaf Technical Details

All sizes are in mm

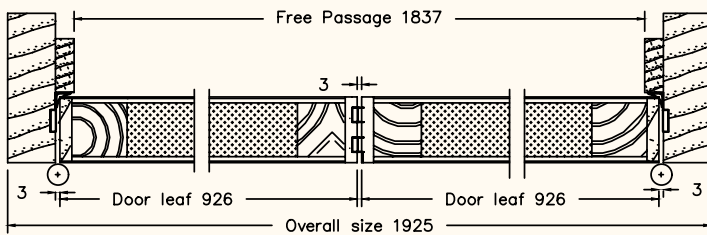
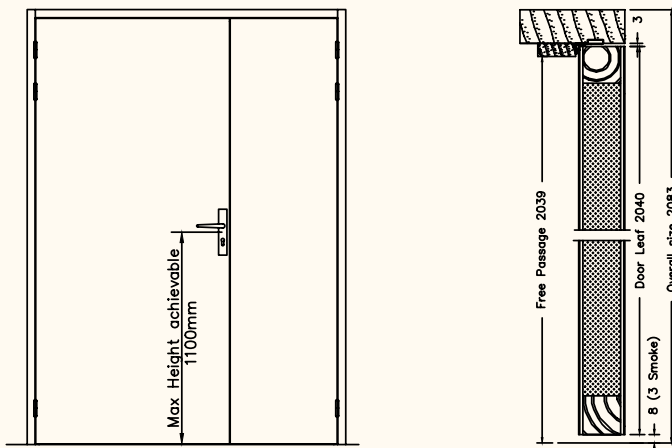
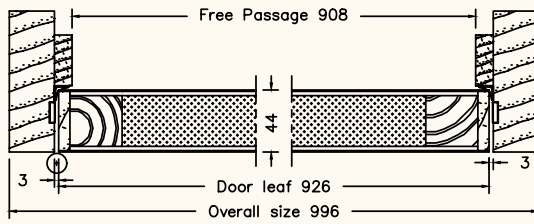
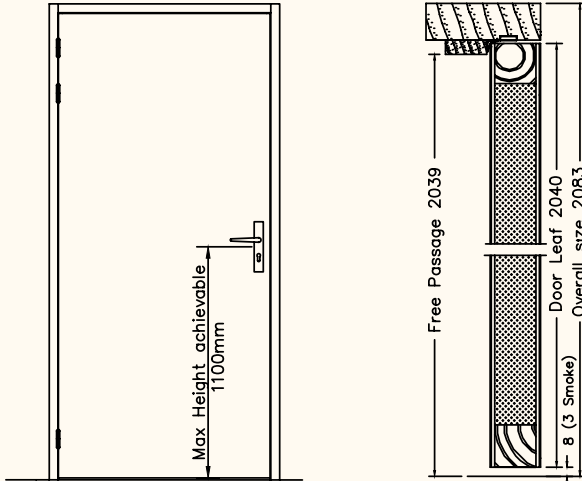

Meeting stiles available

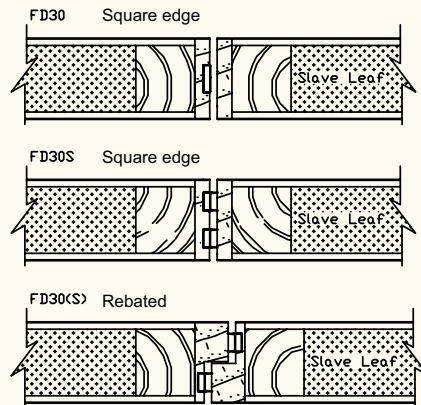



**Timber Fire-rated Door Sets**

# FD30 FIRE AND SMOKE DOUBLE SWING

*(Single and Double Leaf)*

**Door Leaf**

- Arnold Laver high density three layered particleboard complete with lippings
- Thickness 44mm
- Door core construction can vary pending on project requirements

**Door Frame**

- Available in the following materials:
  - Hardwood (470 kg/m<sup>3</sup>)
- Available in the following profiles:
  - Plain lining

**Choice of Door Facings**

- Primed only for site finish
- Veneers - crown cut as standard, specials upon request
- Laminate
- Acrovyn (PVC)

**Ironmongery**

- Doors can incorporate CE marked or certified approved hardware subject to compatibility with the door blank

**Perimeter Seals**

- Fire only
- Combined fire and smoke
- It is recommended that all intumescent seals are factory fitted as standard

All door sets and door kits comply with 'Technical Schedule TS10 Fire Resisting Pedestrian Type Hinged or Pivoted Door Sets'.

**Features**



**FD30**

Fire tested and certified providing fire resistance of 30 minutes integrity as defined in BS 476: Part 22

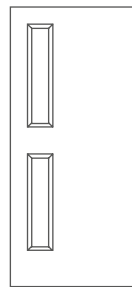

AL54

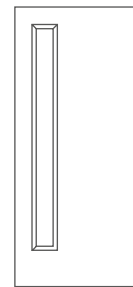

AL01

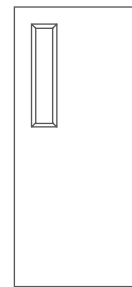

AL56

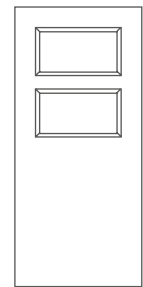

AL63

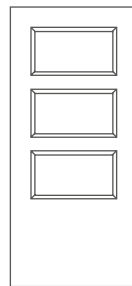

AL38

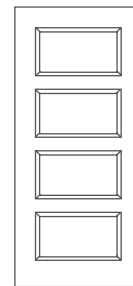

AL37

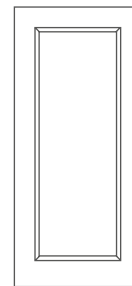

AL16

These are our most commonly specified glazed designs, others are available upon request.

Single and Double Leaf Technical Details

All sizes are in mm

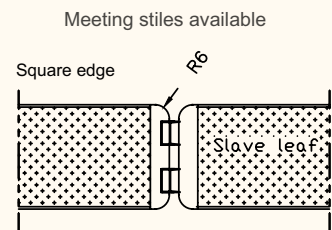
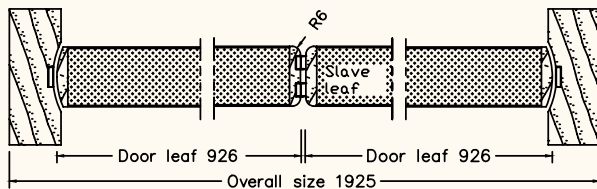
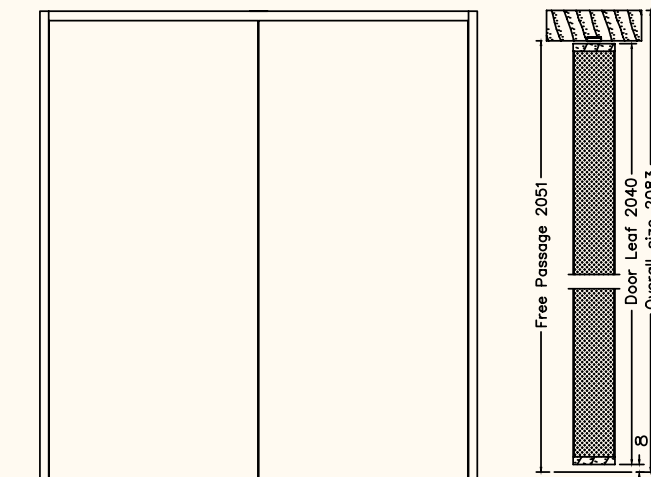
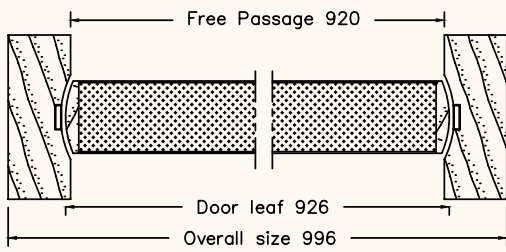
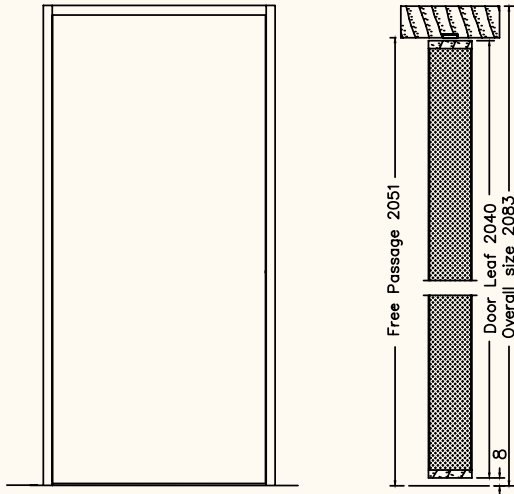

**Timber Fire-rated Door Sets**

**FD60 FIRE AND SMOKE**

*(Single and Double Leaf)*

**Door Leaf**

- Arnold Laver high density three layered particleboard complete with lippings
- Thickness 54mm
- Door core construction can vary pending on project requirements
- Doors can incorporate an over panel to meet project requirements

**Door Frame**

- Available in the following materials:
  - MDF (suitable for single-acting door sets up to 2040 x 826 or 1981 x 838mm only)
  - Hardwood (minimum density 640 kg/m<sup>3</sup>)
- Available in the following profiles:
  - Plain lining and loose stop
  - Rebated frame (casing)

**Choice of Door Facings**

- Primed only for site finish
- Veneers - crown cut as standard, specials upon request
- Laminate
- Acrovyn (PVC)

**Ironmongery**

- Supplied with either lift-off or butt hinge as standard
- Optional drop seal
- Doors can incorporate CE marked or certified approved hardware subject to compatibility with the door blank

**Perimeter Seal Options**

- Fire only
- Combined fire and smoke
- Separate fire and smoke seal
- It is recommended that all intumescent seals are factory fitted as standard

All door sets and door kits comply with 'Technical Schedule TS10 Fire Resisting Pedestrian Type Hinged or Pivoted Door Sets'.

**Features**



**FD60**

Fire tested and certified providing fire resistance of 60 minutes integrity as defined in BS 476: Part 22.



**Smoke Seal**

Appropriate integral smoke seals can be applied to restrict smoke leakage as defined in BS 476: Part 31.1: 1983 and Appendix B of approved Document B

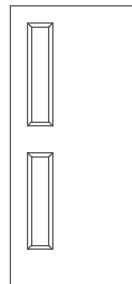

AL54

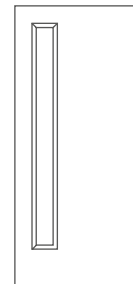

AL01

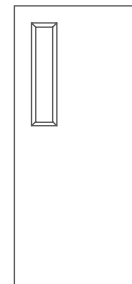

AL56

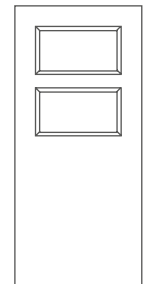

AL63

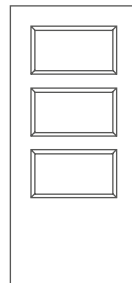

AL38

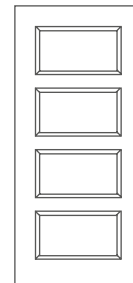

AL37

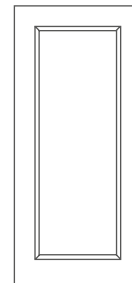

AL16

These are our most commonly specified glazed designs, others are available upon request.

Single and Double Leaf Technical Details

All sizes are in mm

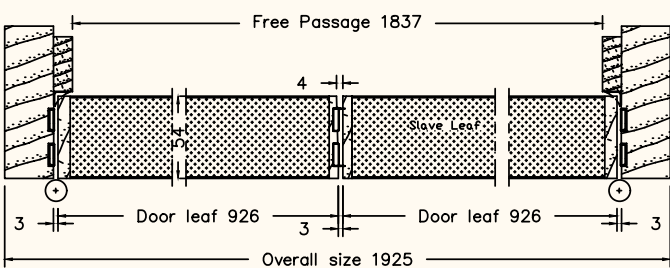
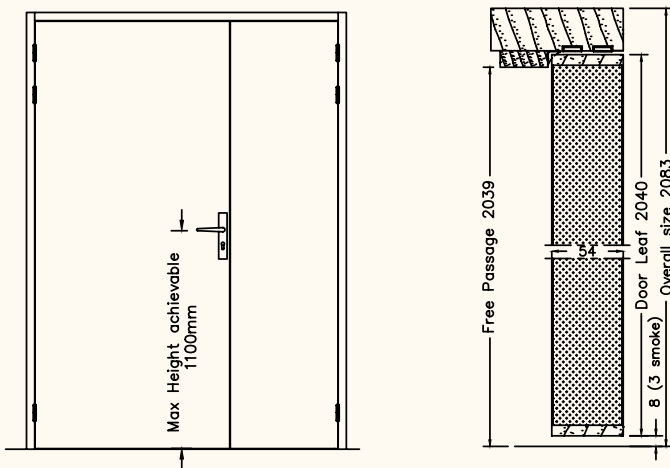
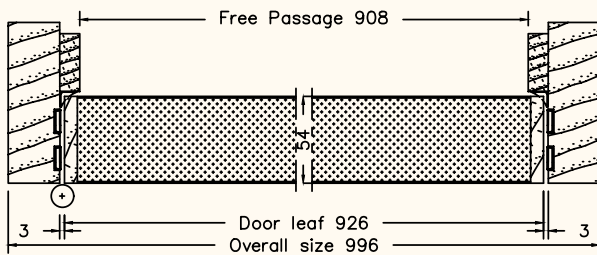
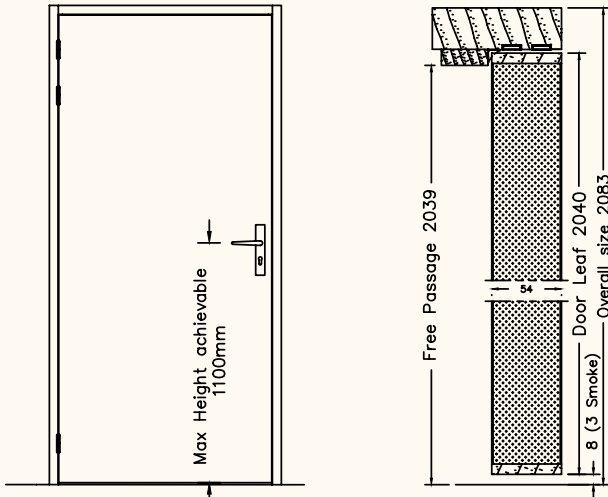

Meeting stiles available

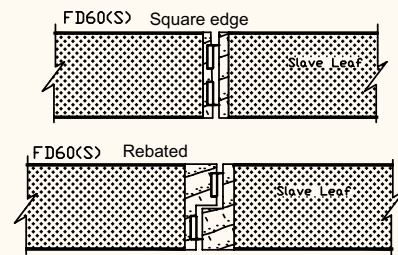

**Timber Acoustic Door Sets**

**NON-FIRE ACOUSTIC 27-31**

(Single Leaf)

**Door Leaf**

- Arnold Laver high density flaxboard core complete with European whitewood stiles and rails (door facing supplied in either MDF, chipboard or hardwood)
- Thickness 44mm
- Door core construction can vary pending on project requirements
- Doors can incorporate an over panel to meet project requirements

**Door Frame**

- Available in the following materials:
  - MDF
  - Softwood
  - Hardwood
- Available in the following profiles:
  - Plain lining and loose stop
  - Rebated frame (casing)

**Choice of Door Facings**

- Primed only for site finish
- Veneers - crown cut as standard, specials upon request
- Laminate
- Acrovyn (PVC)

**Ironmongery**

- Supplied with either lift-off or butt hinge as standard
- Drop seal standard
- Doors can incorporate CE marked or certified approved hardware subject to compatibility with the door blank

**Perimeter Seals**

- Combined acoustic and smoke seal
- It is recommended that all intumescent seals are factory fitted as standard

All door sets and door kits comply with 'Technical Schedule TS10'.

**Features**



**27Db to 31dB**

Performance tested in conditions of BS EN ISO 10140:2010 and rated in accordance with BS EN ISO 717-1:2013



**Smoke Seal**

Appropriate integral smoke seals applied to achieve acoustic performance

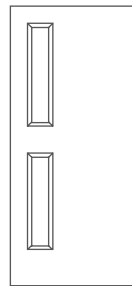

AL54

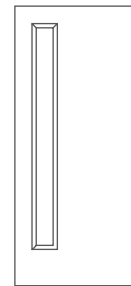

AL01

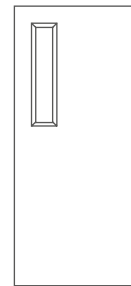

AL56

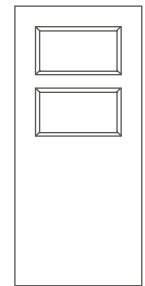

AL63

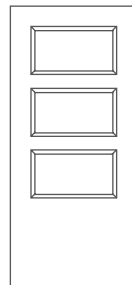

AL38

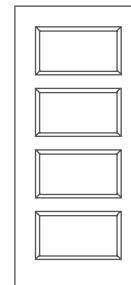

AL37

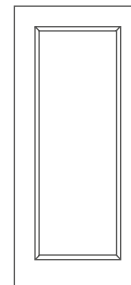

AL16

These are our most commonly specified glazed designs, others are available upon request.



Technical Details

All sizes are in mm

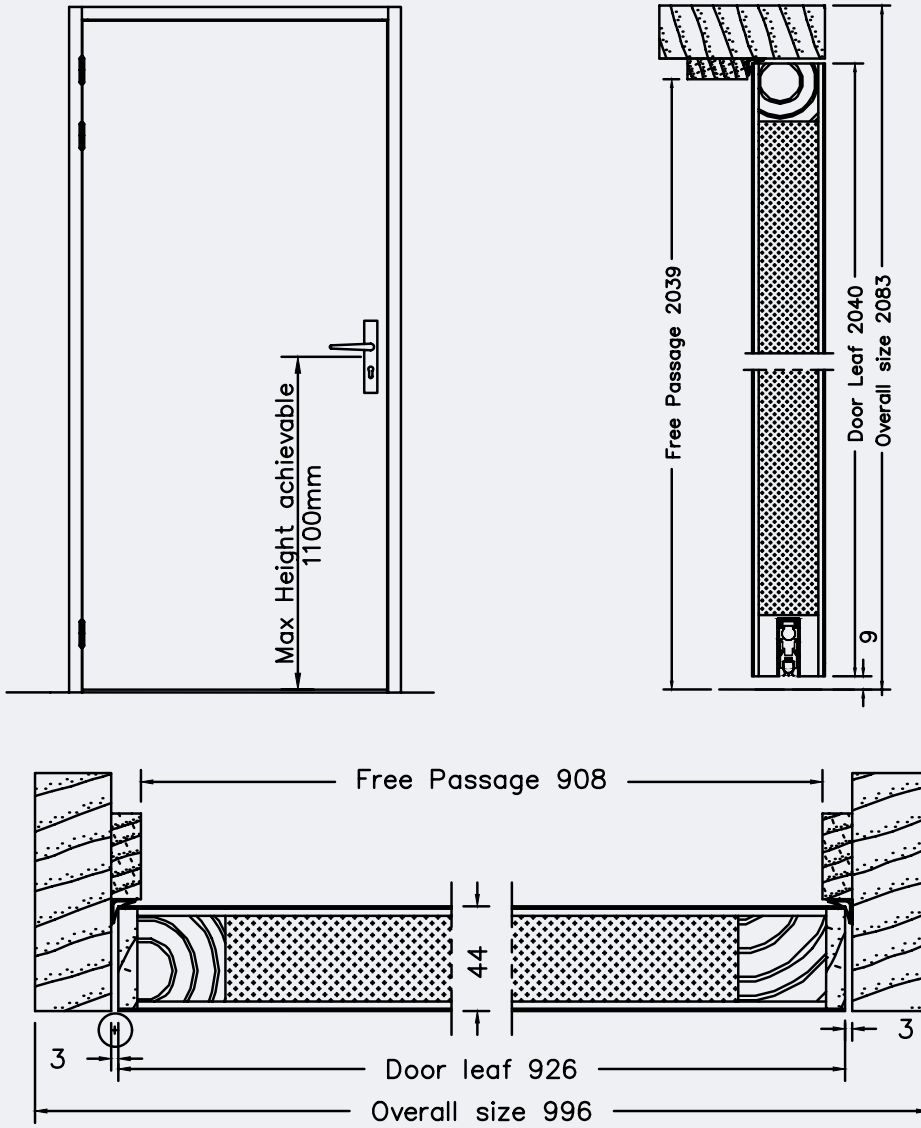

LAS8001 Drop seal C/W optional  
LAS4001 Threshold

### Timber Acoustic Door Sets

# NON-FIRE ACOUSTIC 33-35

(Single Leaf)

#### Door Leaf

- Arnold Laver high density three layered particleboard complete with lippings
- Thickness 54mm
- Door core construction can vary pending on project requirements

#### Door Frame

- Available in the following materials:
  - MDF
  - Hardwood
- Available in the following profiles:
  - Plain lining and loose stop
  - Rebated frame (casing)

#### Choice of Door Facings

- Primed only for site finish
- Veneers - crown cut as standard, specials upon request
- Laminate
- Acrovyn (PVC)

#### Ironmongery

- Supplied with either lift-off or butt hinge as standard
- Drop seal standard
- Doors can incorporate CE marked or certified approved hardware subject to compatibility with the door blank

#### Perimeter Seal Options

- Combined acoustic and smoke seal
- It is recommended that all intumescent seals are factory fitted as standard

All door sets and door kits comply with 'Technical Schedule TS10'.

#### Features



#### 33dB to 35dB

Tested in conditions of BS EN ISO 10140:2010 and rated in accordance with BS EN ISO 717-1:2013



#### Smoke Seal

Appropriate integral smoke seals applied to achieve acoustic performance

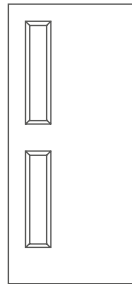

AL54

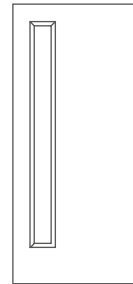

AL01

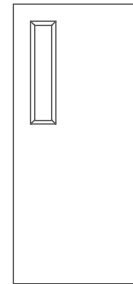

AL56

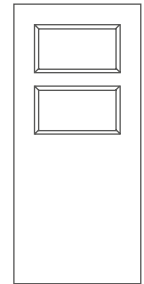

AL63

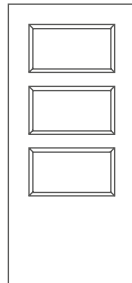

AL38

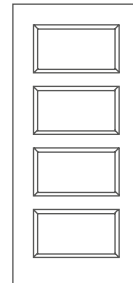

AL37

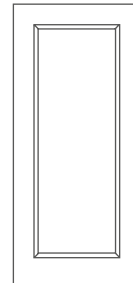

AL16

These are our most commonly specified glazed designs, others are available upon request.

Technical Details

All sizes are in mm

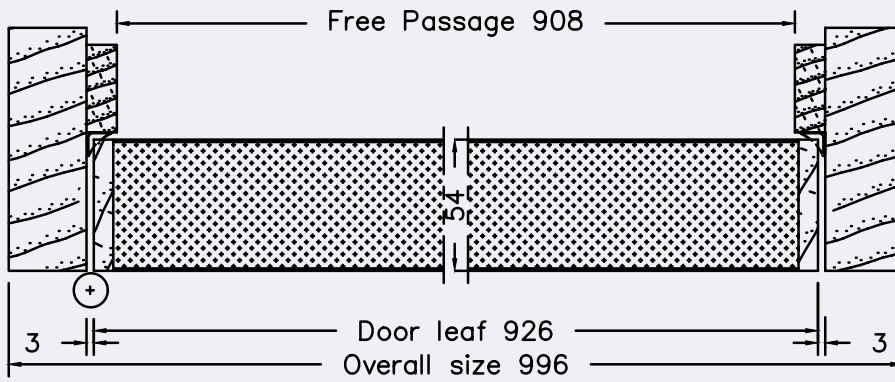
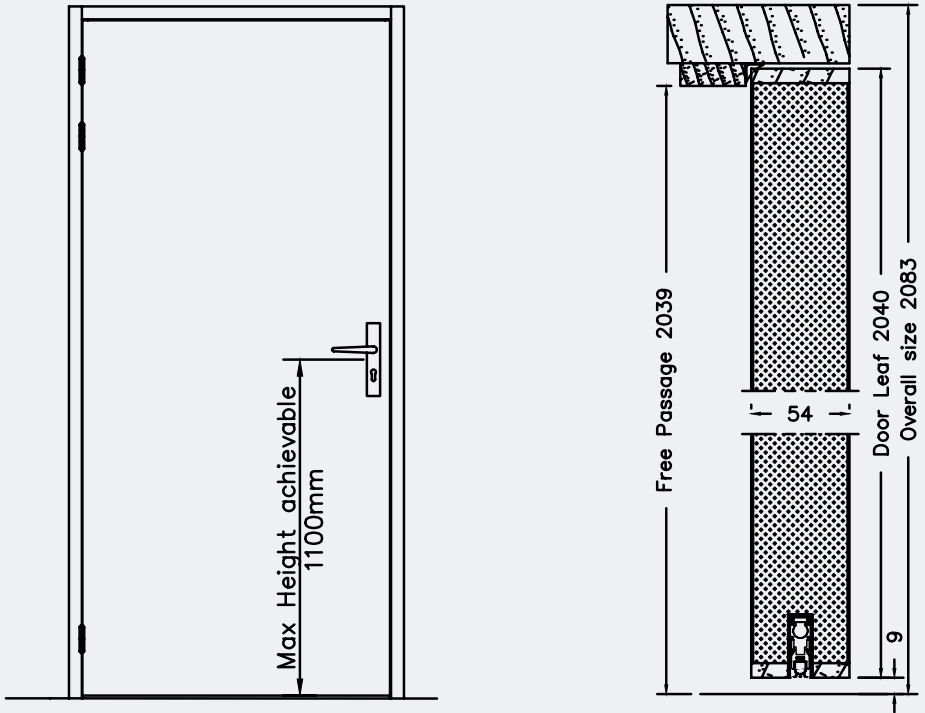

LAS8001 Drop seal C/W optional  
LAS4001 Threshold

**Timber Acoustic Door Sets**

**FD30 FIRE AND ACOUSTIC 29-32**

(Single Leaf)

**Door Leaf**

- Arnold Laver high density flaxboard core complete with European whitewood stiles and rails (door facing supplied in either MDF, chipboard, hardwood)
- Thickness 44mm
- Door core construction can vary pending on project requirements

**Door Frame**

- Available in the following materials:
  - MDF
  - Softwood (solid or engineered)
  - Hardwood
- Available in the following profiles:
  - Plain lining and loose stop
  - Rebated frame (casing)

**Choice of Door Facings**

- Primed only for site finish
- Veneers - crown cut as standard, specials upon request
- Laminate

**Ironmongery**

- Supplied with either lift-off or butt hinge as standard
- Drop seal LAS8001
- Doors can incorporate CE marked or certified approved hardware subject to compatibility with the door blank

**Perimeter Seal Options**

- Combined fire and smoke
- Separate smoke seal
- It is recommended that all intumescent seals are factory fitted as standard

All door sets and door kits comply with 'Technical Schedule TS10 Fire Resisting Pedestrian Type Hinged or Pivoted Door Sets'.

**Features**



**FD30**

Fire tested and certified providing fire resistance of 30 minutes integrity as defined in BS 476: Part 22.



**29dB to 32dB**

Performance tested in conditions of BS EN ISO 10140:2010 and rated in accordance with BS EN ISO 717-1:2013



**Smoke Seal**

Appropriate integral smoke seals can be applied to restrict smoke leakage as defined in BS 476: Part 31.1: 1983 and Appendix B of approved Document B

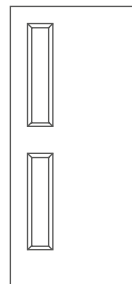

AL54

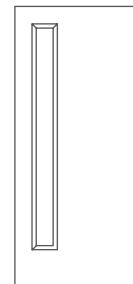

AL01

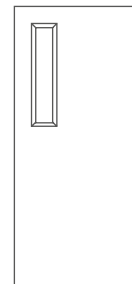

AL56

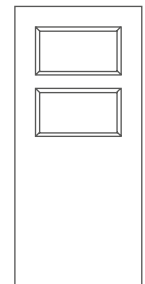

AL63

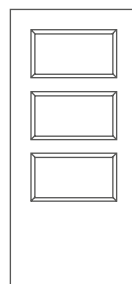

AL38

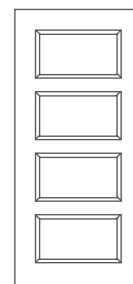

AL37

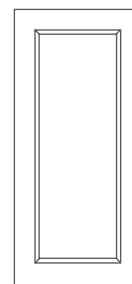

AL16

These are our most commonly specified glazed designs, others are available upon request.

Technical Details

All sizes are in mm

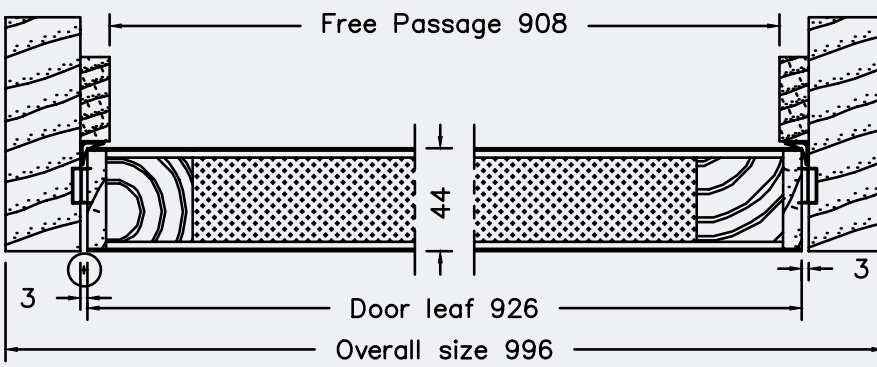
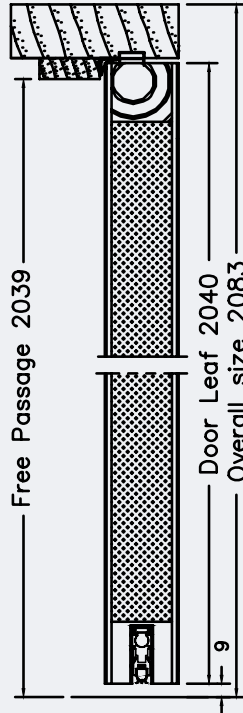
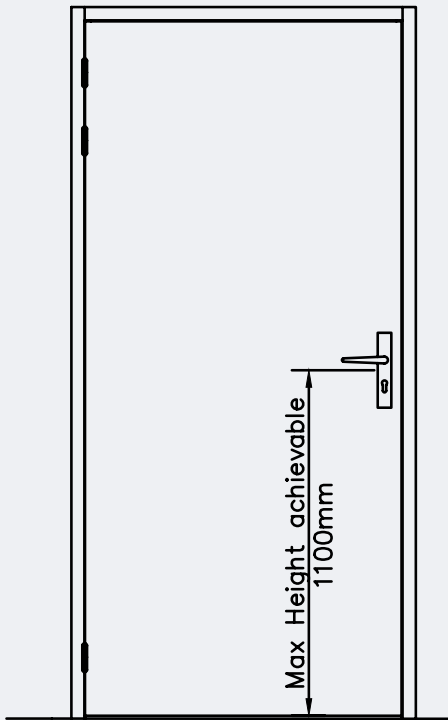

LAS8001 Drop seal C/W optional  
LAS4001 Threshold



**Timber Acoustic Door Sets**

**FD30 FIRE AND ACOUSTIC 35 GLAZED**

(Single Leaf)

**Door Leaf**

- Arnold Laver high density three layered particleboard complete with lippings
- Thickness 44mm
- Door core construction can vary pending on project requirements

**Door Frame**

- Available in the following materials:
  - MDF
  - Softwood (solid or engineered)
  - Hardwood
- Available in the following profiles:
  - Plain lining and loose stop
  - Rebated frame (casing)

**Choice of Door Facings**

- Primed only for site finish
- Veneers – crown cut as standard, specials upon request
- Laminate
- Acrovyn (PVC)

**Ironmongery**

- Supplied with either lift-off or butt hinge as standard
- Drop seal LAS8001
- Doors can incorporate CE marked or certified approved hardware subject to compatibility with the door blank

**Perimeter Seal Options**

- Combined fire and smoke
- Separate fire and smoke seal
- It is recommended that all intumescent seals are factory fitted as standard

All door sets and door kits comply with 'Technical Schedule TS10 Fire Resisting Pedestrian Type Hinged or Pivoted Door Sets'.

**Features**



**FD30**

Fire tested and certified providing fire resistance of 30 minutes integrity as defined in BS 476: Part 22.



**35dB**

Performance tested in conditions of BS EN ISO 10140:2010 and rated in accordance with BS EN ISO 717-1:2013



**Smoke Seal**

Appropriate integral smoke seals can be applied to restrict smoke leakage as defined in BS 476: Part 31.1:1983 and Appendix B of approved Document B

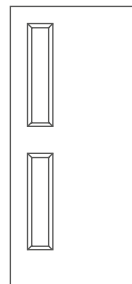

AL54

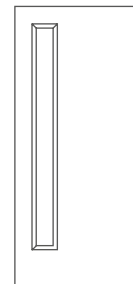

AL01

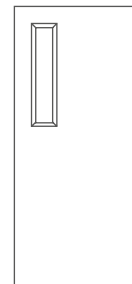

AL56

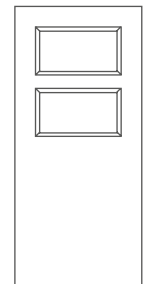

AL63

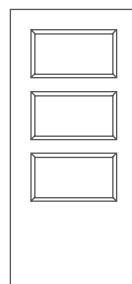

AL38

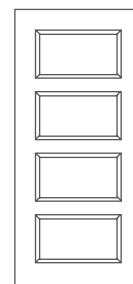

AL37

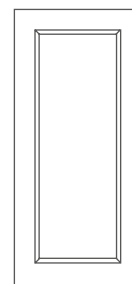

AL16

These are our most commonly specified glazed designs, others are available upon request.

Technical Details

All sizes are in mm

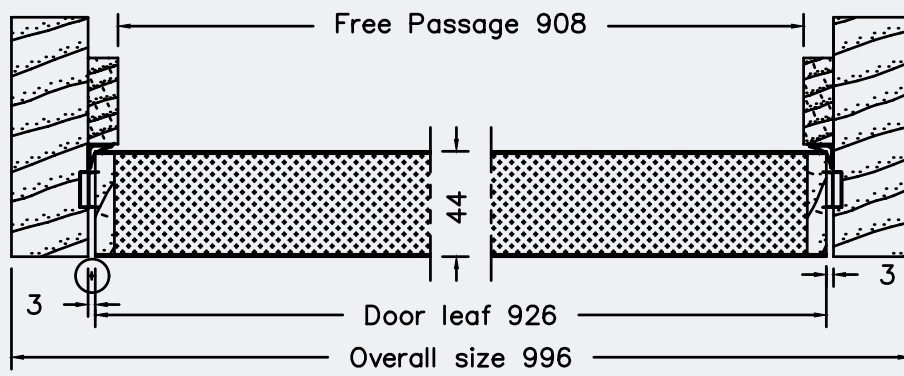
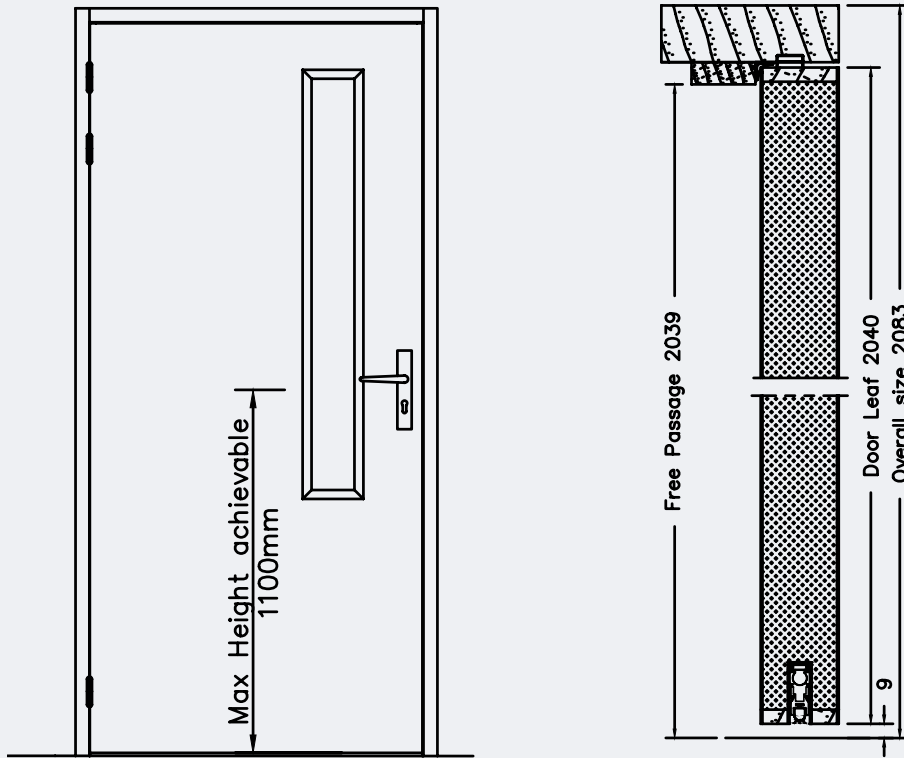

LAS8001 Drop seal C/W optional  
LAS4001 Threshold

**Timber Acoustic Door Sets**

**FD60 FIRE AND ACOUSTIC 33-35**

*(Single Leaf)*

**Door Leaf**

- Arnold Laver high density three layered particleboard complete with hardwood lippings
- Thickness 54mm
- Door core construction can vary pending on project requirements

**Door Frame**

- Available in the following materials:  
Hardwood (Minimum density 640 kg/m<sup>3</sup>)
- Available in the following profiles:  
– Plain lining and loose stop  
– Rebated frame (casing)

**Choice of Door Facings**

- Primed only for site finish
- Veneers - crown cut as standard, specials upon request
- Laminate
- Acrovyn (PVC)

**Ironmongery**

- Supplied with either lift-off or butt hinge as standard
- Drop seal as standard
- Doors can incorporate CE marked or certified approved hardware subject to compatibility with the door blank

**Perimeter Seal Options**

- Combined fire and smoke
- Separate smoke and acoustic

All door sets and door kits comply with 'Technical Schedule TS10 Fire Resisting Pedestrian Type Hinged or Pivoted Door Sets'.

**Features**



**FD60**

Fire tested and certified providing fire resistance of 60 minutes integrity as defined in BS 476: Part 22.



**33dB to 35dB**

Performance tested in conditions of BS EN ISO 10140:2010 and rated in accordance with BS EN ISO 717-1:2013



**Smoke Seal**

Appropriate integral smoke seals can be applied to restrict smoke leakage as defined in BS 476: Part 31.1:1983 and Appendix B of approved Document B

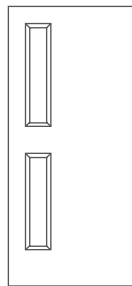

AL54

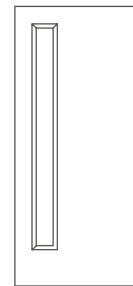

AL01

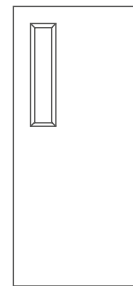

AL56

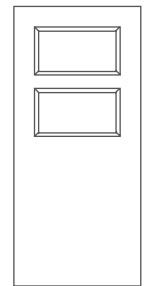

AL63

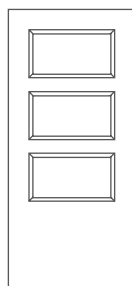

AL38

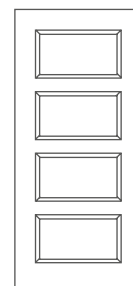

AL37

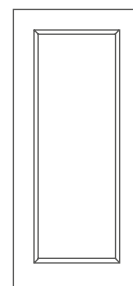

AL16

These are our most commonly specified glazed designs, others are available upon request.

Technical Details

All sizes are in mm

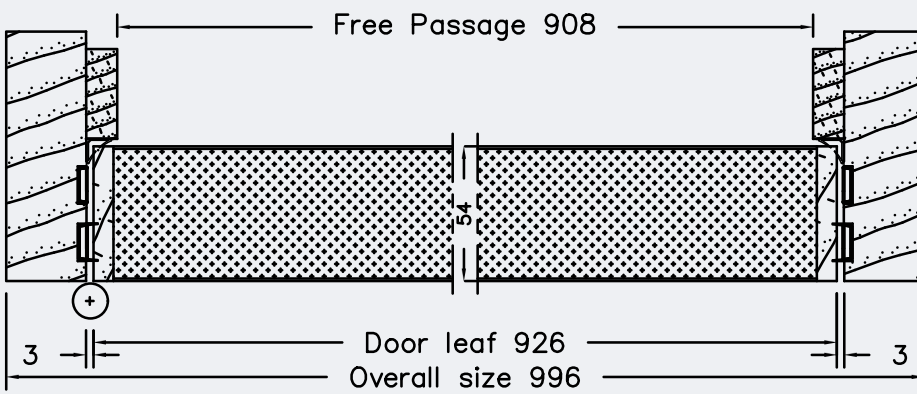
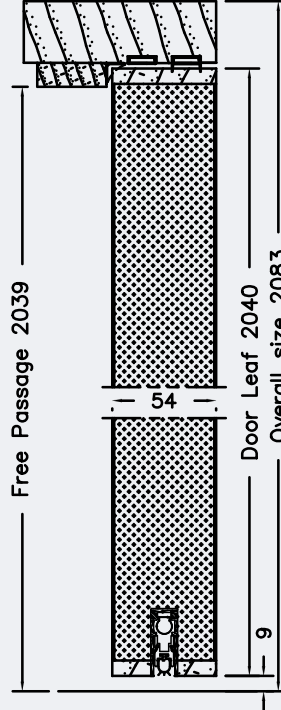
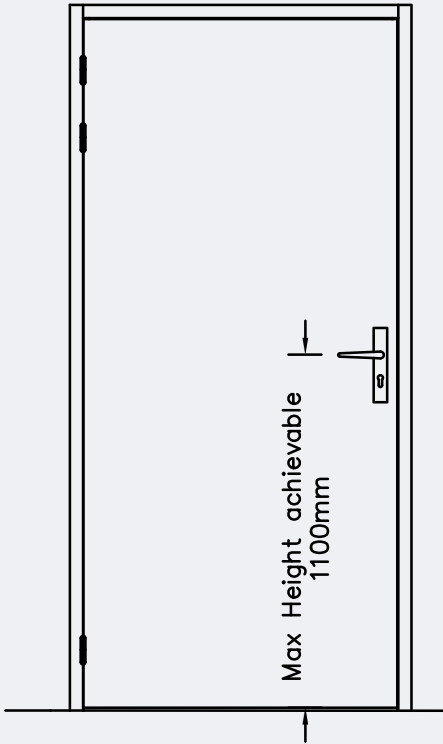

LAS8001 sl (shown with LAS4001)

**Timber Acoustic Door Sets**

**FD60 FIRE AND ACOUSTIC 36 GLAZED**

*(Single Leaf Glazed)*

**Door Leaf**

- Arnold Laver high density three layered particleboard complete with lippings
- Thickness 54mm
- Door core construction can vary pending on project requirements

**Door Frame**

- Available in the following materials:
  - Hardwood (minimum density 640 kg/m<sup>3</sup>)
- Available in the following profiles:
  - Plain lining and loose stop
  - Rebated frame (casing)

**Choice of Door Facings**

- Primed only for site finish
- Veneers – crown cut as standard, specials upon request
- Laminate
- Acrovyn (PVC)

**Ironmongery**

- Supplied with either lift-off or butt hinge as standard
- Drop seal as standard
- Doors can incorporate CE marked or certified approved hardware subject to compatibility with the door blank

**Perimeter Seal Options**

- Combined fire and smoke
- Separate smoke and acoustic
- It is recommended that all intumescent seals are factory fitted as standard

All door sets and door kits comply with 'Technical Schedule TS10 Fire Resisting Pedestrian Type Hinged or Pivoted Door Sets'.

**Features**



**FD60**

Fire tested and certified providing fire resistance of 60 minutes integrity as defined in BS 476: Part 22.



**36dB**

Performance tested in conditions of BS EN ISO 10140:2010 and rated in accordance with BS EN ISO 717-1:2013



**Smoke Seal**

Appropriate integral smoke seals can be applied to restrict smoke leakage as defined in BS 476: Part 31.1:1983 and Appendix B of approved Document B

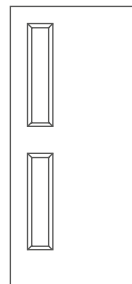

AL54

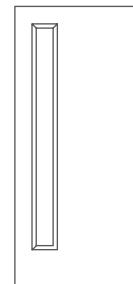

AL01

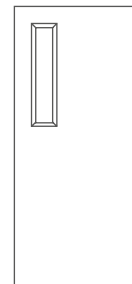

AL56

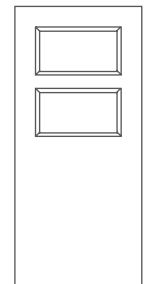

AL63

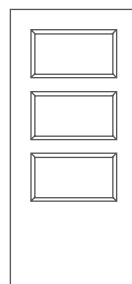

AL38

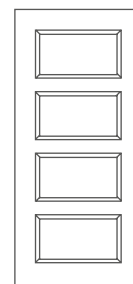

AL37

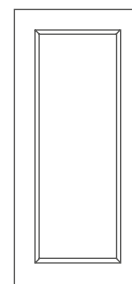

AL16

These are our most commonly specified glazed designs, others are available upon request.



Technical Details

All sizes are in mm

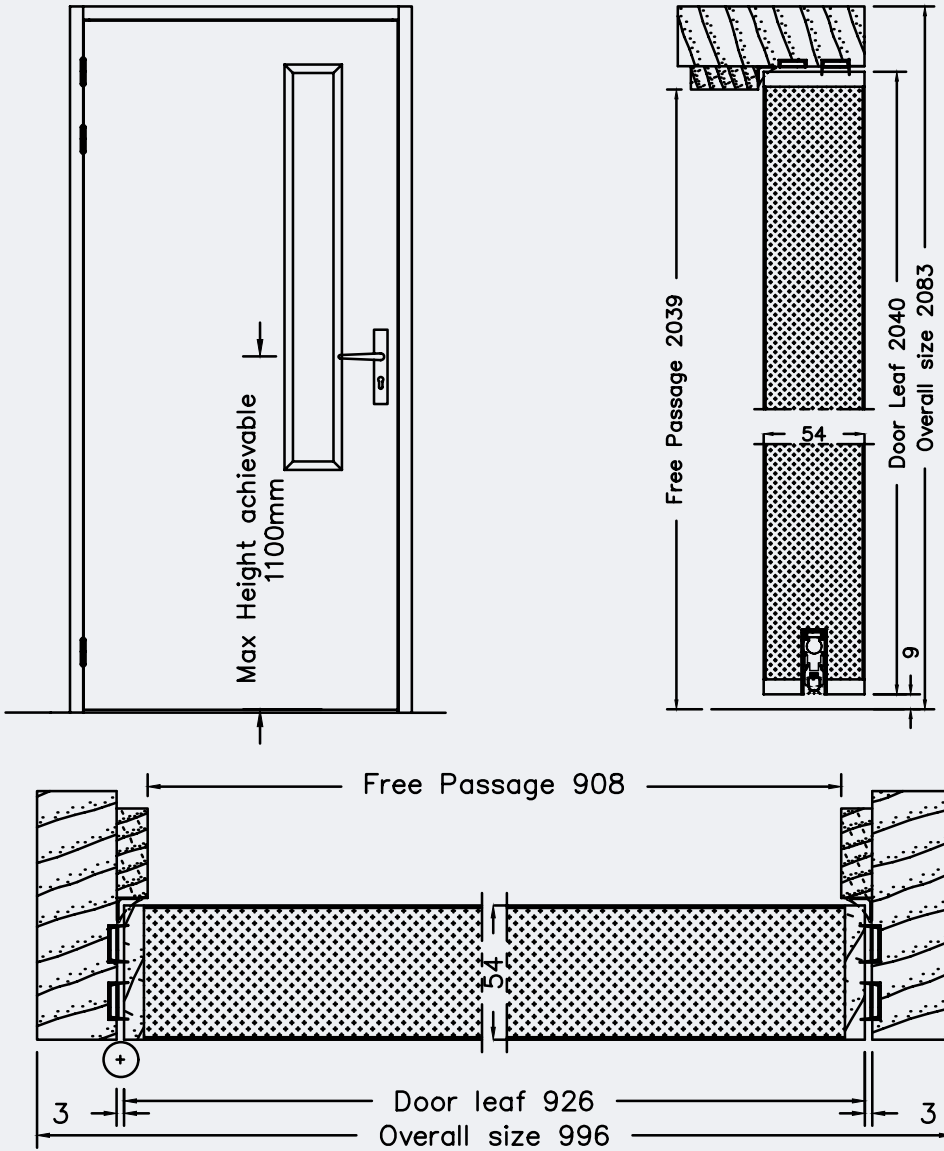

**Timber Acoustic Door Sets**

**FD60 FIRE AND ACOUSTIC 36 GLAZED**

*(Double Leaf Glazed)*

**Door Leaf**

- Arnold Laver high density three layered particleboard complete with lippings
- Thickness 54mm
- Door core construction can vary pending on project requirements

**Door Frame**

- Available in the following materials:
  - Hardwood (minimum density 640 kg/m<sup>3</sup>)
- Available in the following profiles:
  - Plain lining and loose stop
  - Rebated frame (casing)

**Choice of Door Facings**

- Primed only for site finish
- Veneers - crown cut as standard, specials upon request
- Laminate
- Acrovyn (PVC)

**Ironmongery**

- Supplied with either lift-off or butt hinge as standard
- Drop seal as standard
- Doors can incorporate CE marked or certified approved hardware subject to compatibility with the door blank

**Perimeter Seal Options**

- Combined fire and smoke
- Separate smoke and acoustic seal
- It is recommended that all intumescent seals are factory fitted as standard

All door sets and door kits comply with 'Technical Schedule TS10 Fire Resisting Pedestrian Type Hinged or Pivoted Door Sets'.

**Features**



**FD60**

Fire tested and certified providing fire resistance of 60 minutes integrity as defined in BS 476: Part 22.



**36dB**

Performance tested in conditions of BS EN ISO 10140:2010 and rated in accordance with BS EN ISO 717-1:2013



**Smoke Seal**

Appropriate integral smoke seals can be applied to restrict smoke leakage as defined in BS 476: Part 31.1:1983 and Appendix B of approved Document B

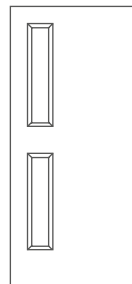

AL54

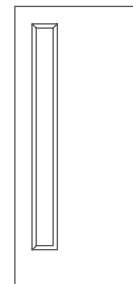

AL01

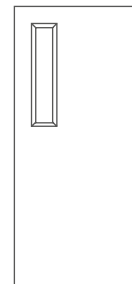

AL56

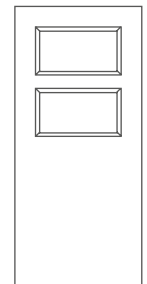

AL63

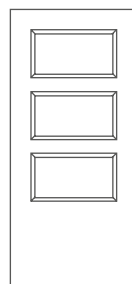

AL38

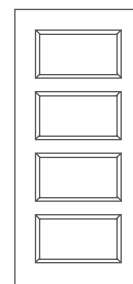

AL37

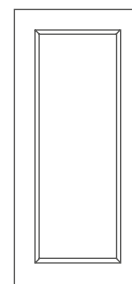

AL16

These are our most commonly specified glazed designs, others are available upon request.

Technical Details

All sizes are in mm

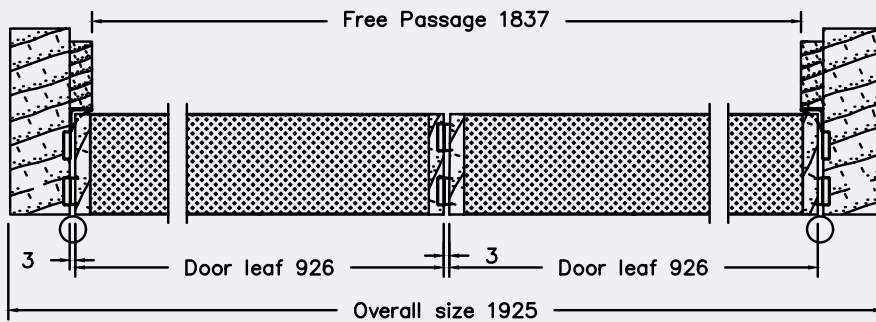
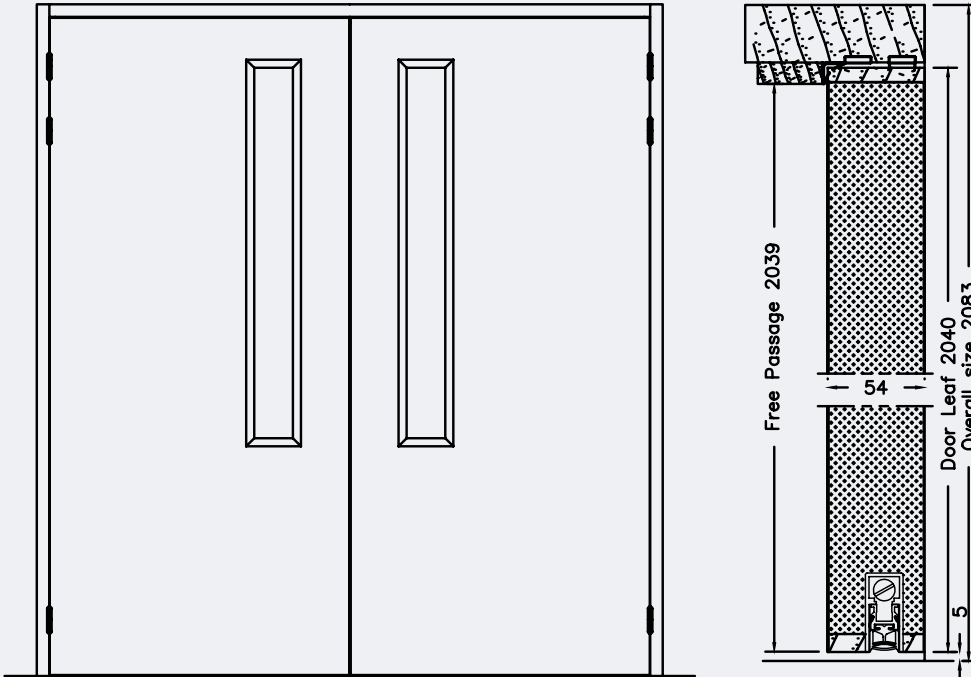

LAS8040 Drop seal C/W optional LAS4001 Threshold

Meeting stiles available

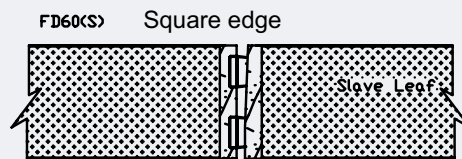

## Timber Security Door Sets

# FD30 FIRE AND SECURITY

(Single Leaf)

### Door Leaf

- Arnold Laver high density three layered particleboard complete with lippings
- Thickness 44mm
- Door core construction can vary pending on project requirements

### Door Frame

- Available in the following materials
  - Softwood (minimum density 510 kg/m<sup>3</sup>)
  - Hardwood (minimum density 510 kg/m<sup>3</sup>)
- Available in the following profiles:
  - Rebated frame (casing)
  - Timber threshold supplied as standard

### Choice of Door Facings

- Primed only for site finish
- Veneers - crown cut as standard, specials upon request
- Laminate
- Acrovyn (PVC)

### Ironmongery

- 3nr hinges
- 3-point multi-lock
- Double Euro cylinder
- Escutcheon
- Lever handles on rose
- Drop seal as standard
- Optional:
  - Letter plate
  - Door viewer

### Perimeter Seal Options

- Fire only
- Separate smoke and acoustic
- All seals factory fitted as standard

All door sets and door kits comply with 'Technical Schedule TS10 Fire Resisting Pedestrian Type Hinged or Pivoted Door Sets'.

### Features



#### FD30

Fire tested and certified providing fire resistance of 30 minutes integrity as defined in BS 476: Part 22.



#### 32dB



#### Smoke Seal

Appropriate integral smoke seals can be applied to restrict smoke leakage as defined in BS 476: Part 31.1: 1983 and Appendix B of approved Document B



#### Security – PAS24 and SBD

Tested to PAS24 and Secured by Design enhanced security standards.

Glazing options available, contact office for more details.

Technical Details

All sizes are in mm

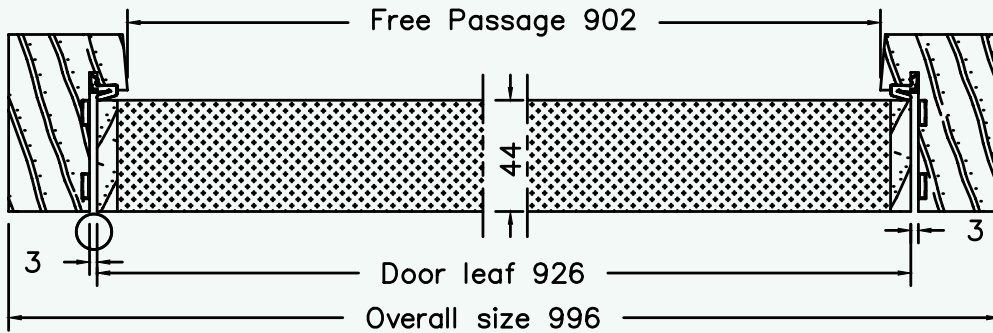
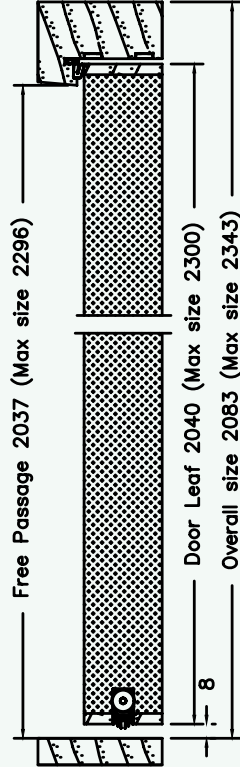
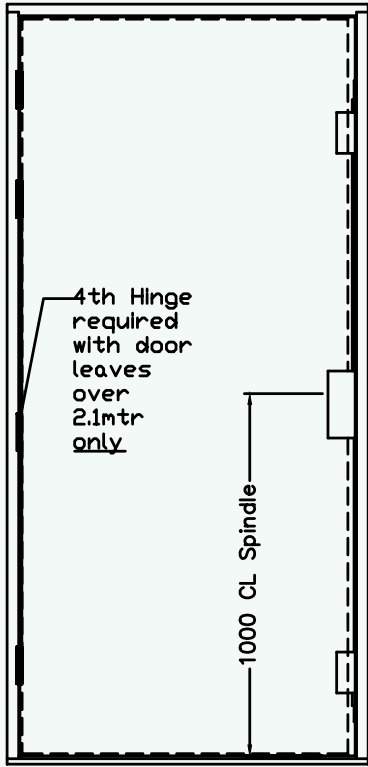



## Timber Security Door Sets

# FD30 FIRE AND SECURITY

(Double Leaf)

### Door Leaf

- Arnold Laver high density three layered particleboard complete with lippings
- Thickness 54mm
- Door core construction can vary pending on project requirements

### Door Frame

- Available in the following materials:
  - Softwood (minimum density 510 kg/m<sup>3</sup>)
  - Hardwood (minimum density 510 kg/m<sup>3</sup>)
- Available in the following profiles:
  - Rebated frame (casing)
  - Timber threshold supplied as standard

### Choice of Door Facings

- Primed only for site finish
- Veneers - crown cut as standard, specials upon request
- Laminate
- Acrovyn (PVC)

### Ironmongery

- 3nr hinges per leaf
- 3-point multi-lock
- Flush bolt system to slave leaf
- Double Euro cylinder
- Escutcheon
- Lever handles on rose
- Drop seal as standard
- Optional:
  - Letter plate
  - Door viewer

### Perimeter Seal Options

- Fire only
- Separate smoke and acoustic seal
- All seals factory fitted as standard

All door sets and door kits comply with 'Technical Schedule TS10 Fire Resisting Pedestrian Type Hinged or Pivoted Door Sets'.

### Features



#### FD30

Fire tested and certified providing fire resistance of 30 minutes integrity as defined in BS 476: Part 22.



#### 27dB



#### Smoke Seal

Appropriate integral smoke seals can be applied to restrict smoke leakage as defined in BS 476: Part 31.1:1983 and Appendix B of approved Document B



#### Security – PAS24 and SBD

Tested to PAS24 and Secured by Design enhanced security standards.

Glazing options available, contact office for more details.

Technical Details

All sizes are in mm

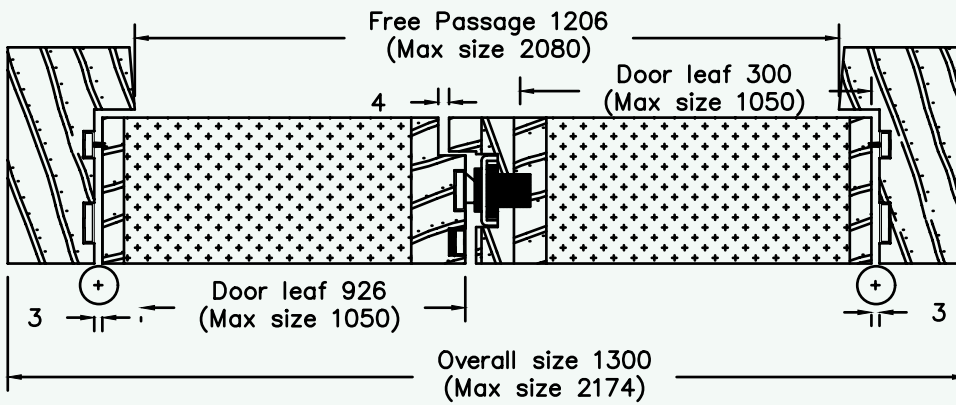
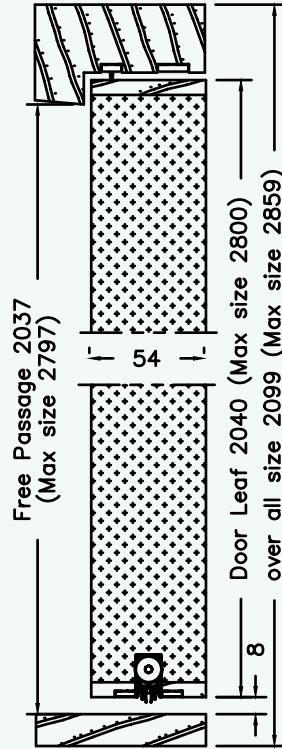
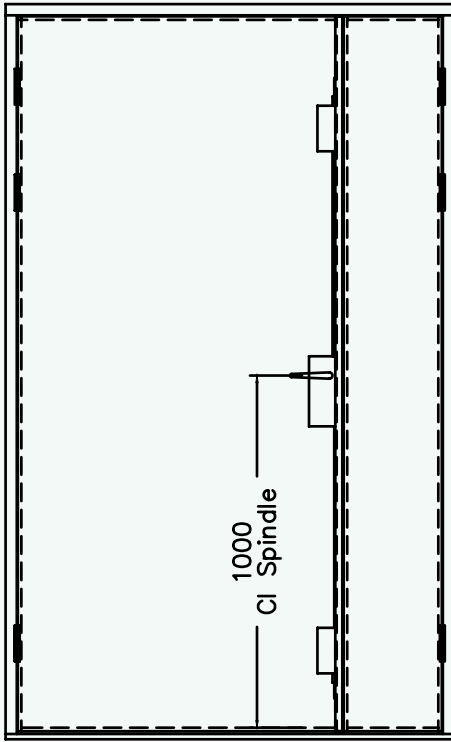

# GLAZING SCREENS

Arnold Laver can supply numerous combinations of screens to suit your project requirements and these can be supplied as a stand alone glazed screen or unit that combines both door and screen.

Screens can also incorporate numerous glass types and glazing systems to suit both fire and acoustic performance, however it must be noted that in some situations safety glass will be required.

Terminology is also a factor in recognising elements of a screen and to assist we have shown typical sections on the drawing.

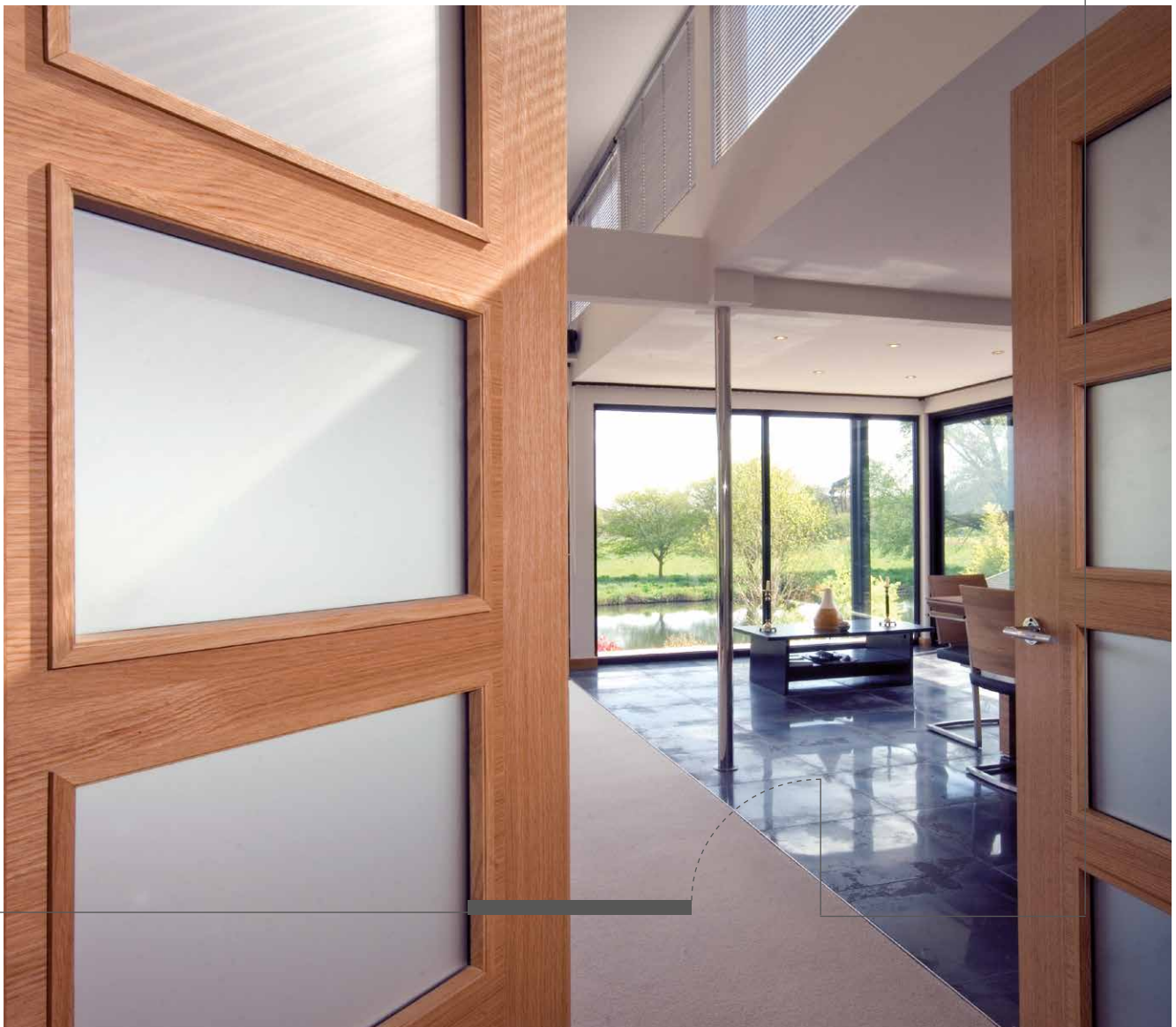

### Technical Details

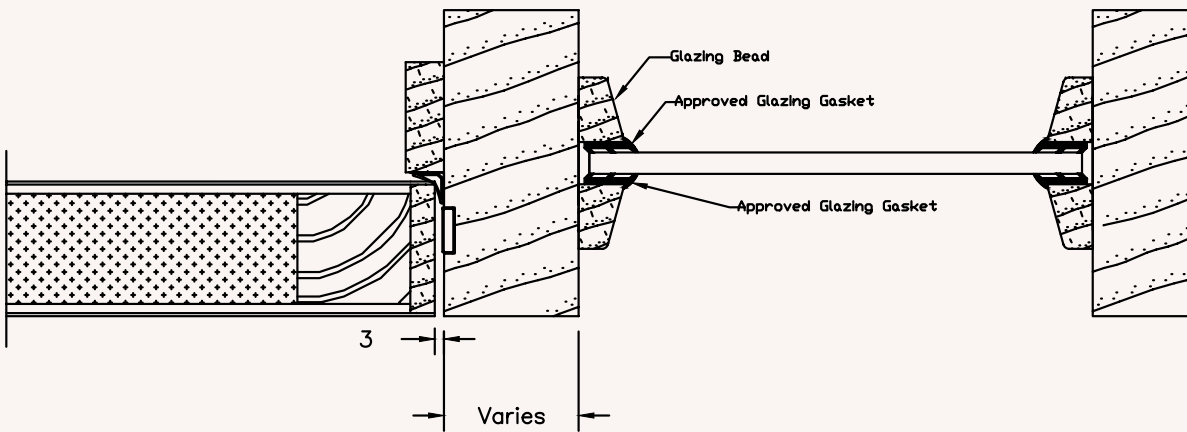
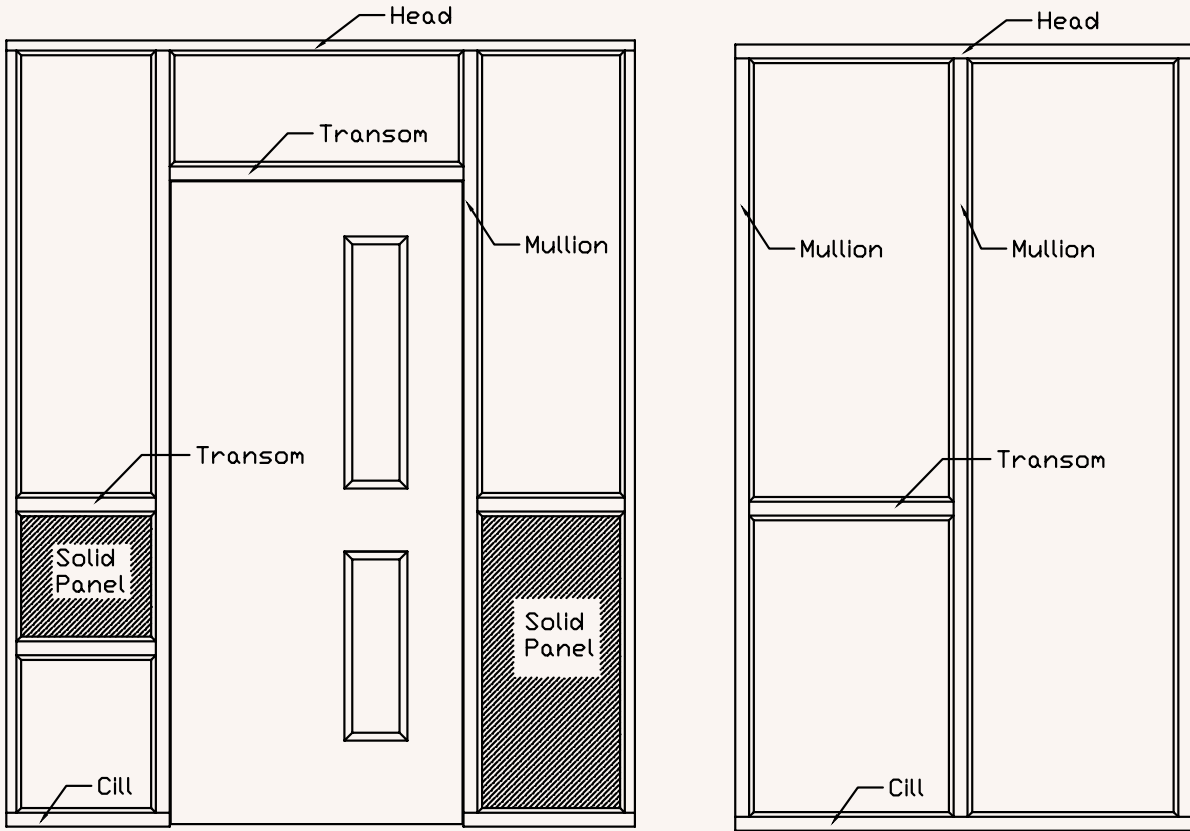

# HUET LAVER DOOR SET RANGES

## Timber Fire-rated

	Number of Leafs	Acoustic Rating (Rw dB)	Wood Frame	Metal Frame	MDF Frame	Smoke Seals	Fire Rating	Stability	Leaf Thickness (mm)	Max Leaf Height (mm)	Max Leaf Width (mm)
<b>EUROFLAM EI30</b>	1	-	●	●	●	●	EI30 / FD30	-	40	2250	1230
<b>EUROFLAM EI30 - DOUBLE LEAF</b>	2	-	●	●	●	●	EI30 / FD30	-	40	2250	930 + 930
<b>EUROFLAM EI30 XXL</b>	1	-	●	●	●	●	EI30 / FD30	-	50	2500	1230
<b>EUROFLAM EI30 XXL - DOUBLE LEAF</b>	2	-	●	●	●	●	EI30 / FD30	-	50	2500	1030 + 1030
<b>EUROFLAM EI60</b>	1	-	●	●	●	●	EI60 / FD60	-	51	2250	1230
<b>EUROFLAM EI60 - DOUBLE LEAF</b>	2	-	●	●	●	●	EI60 / FD60	-	51	2250	1030 + 1030
<b>SWINGING EI30</b>	1	-	●	●			EI30 / FD30	-	50	2250	1030
<b>SWINGING EI30 - DOUBLE LEAF</b>	2	-	●	●			EI30 / FD30	-	50	2250	1030 + 1030
<b>SWINGING EI60</b>	1	-	●	●			EI60 / FD60	-	51	2500	1100
<b>SWINGING EI60 - DOUBLE LEAF</b>	2	-	●	●			EI60 / FD60	-	51	2180	1030 + 1030

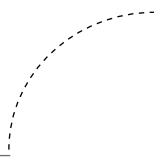



## Acoustic

	Number of Leafs	Acoustic Rating (Rw dB)	Wood Frame	Metal Frame	MDF Frame	Smoke Seals	Fire Rating	Stability	Leaf Thickness (mm)	Max Leaf Height (mm)	Max Leaf Width (mm)
<b>CLUB 30</b>	1	32dB	●	●	●	●	EI30 / FD30	-	40	2250	1230
<b>CLUB 30 – DOUBLE LEAF</b>	2	32dB	●	●	●	●	EI30 / FD30	-	40	2250	930 + 930
<b>CLUB 36</b>	1	37dB	●	●	●	●	EI30 / FD30	-	40	2250	1230
<b>CLUB 36 – DOUBLE LEAF</b>	2	37dB	●	●	●	●	EI30 / FD30	-	40	2250	930 + 930
<b>CLUB 39</b>	1	41dB	●	●	●	●	EI30 / FD30	-	40	2250	1230
<b>CLUB 39 – DOUBLE LEAF</b>	2	39dB	●	●	●	●	EI30 / FD30	-	40	2250	930 + 930
<b>CLUB 39 INTERCONNECTING</b>	2	55dB	●			●	EI30 / FD30	-	40 * 2	2250	1230
<b>CHORUS 39</b>	1	39dB	●	●	●	●	EI30 / FD30	3c	40	2500	1230
<b>CHORUS 42</b>	1	42dB	●	●		●	EI30 / FD30	3c	40	2500	1230
<b>CHORUS 42 – DOUBLE LEAF</b>	2	42dB	●	●		●	EI30 / FD30	3c	40	2250	930 + 930
<b>CHORUS 46</b>	1	46dB	●			●	EI30 / FD30	3c	51	2500	1060
<b>CHORUS 46 – DOUBLE LEAF</b>	2	46dB	●			●	EI30 / FD30	3c	51	2500	1180 + 1180
<b>CHORUS 49</b>	1	48dB	●			●	EI30 / FD30	3c	84	2500	1180
<b>CHORUS 49 – DOUBLE LEAF</b>	2	48dB	●			●	EI30 / FD30	3c	84	2500	1180 + 1180
<b>EUROFLAM EI60 35</b>	1	35dB	●	●		●	EI60 / FD60		51	2250	1230
<b>EUROFLAM EI60 35 – DOUBLE LEAF</b>	2	35dB	●	●		●	EI60 / FD60		51	2250	1030 + 1030
<b>ISADX 3960</b>	1	39dB	●			●	EI60 / FD60	3c	64	2250	930
<b>ISADX 3960 – DOUBLE LEAF</b>	2	39dB	●			●	EI60 / FD60	3c	64	2250	1030 + 1030
<b>ISADX 4260</b>	1	42dB	●			●	EI60 / FD60	3c	64	2250	1030
<b>PAS24 AXIOME 39</b>	1	39dB	●			●	EI30 / FD30	3c	40	2500	1030

## Timber Fire-rated Door Sets

# EUROFLAM EI30

(Single and Double Leaf)

### Door Leaf

- Huet solid timber core
- Thickness: 40mm hardwood stiles all round

### Lippings

- Hardwood
- Concealed or exposed rebated lippings

### Door Frame

- Hardwood
- Rebated monoblock frame
- Variety of widths
- Extension linings available
- Frame can be lacquered, stained or varnished
- Frame can be wrapped with wood veneer to match door leaf facings

### Choice of Door Facings

- Primed
- Wood veneers
- Laminated
- White paint finish and other colour available by request
- Grooved to a wide choice of standard and bespoke finishes

### Ironmongery

- 3 or 4 lift-off hinges - 140 x 70mm mild or stainless steel
- Cut-outs/mortices are available to suit a variety of locks and handles
- Cut-outs/mortices are available to suit a large choice of electromagnetic lock
- Spy hole
- Electric striking plate (available on single leaf)
- Doors can be held in open position using electro-magnetic device. In the event of a fire, doors will assume closed position

### Perimeter Seals

- Intumescent seals factory fitted (within the frame or leaf)
- Combined smoke and acoustic seals fitted within the frame and leaf (tested to meet acoustic performance: Rw 27dB)

### Features



#### EI30

(EITHER SIDE - CS TB RS13-069/A)



#### Smoke Seal

(EN 13501-2/ BS EN 1634-3)

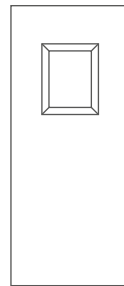

400 x 300

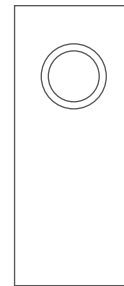

ø360

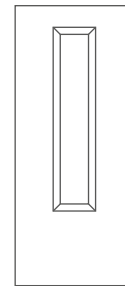

1200 x 200

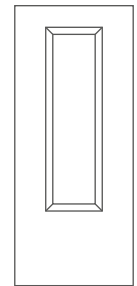

1200 x 300

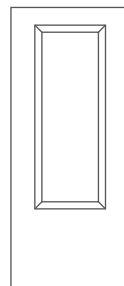

1200 x 400

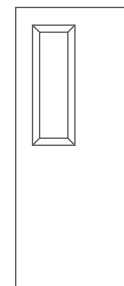

750 x 200

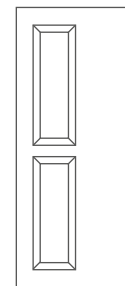

750 x 200  
700 x 200

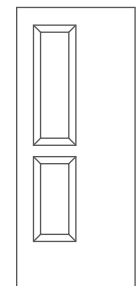

750 x 200  
500 x 200

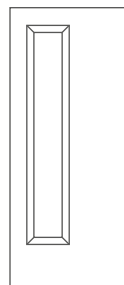

1450 x 200

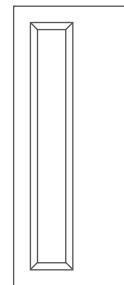

1650 x 200

**Technical Details**

*All sizes are in mm*

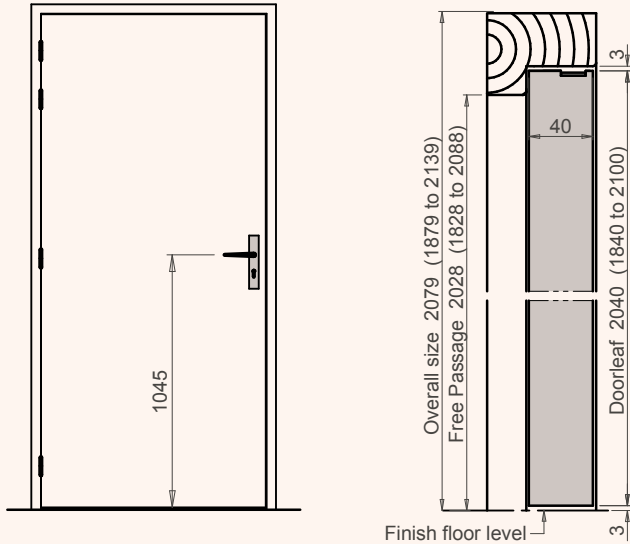

**Meeting stiles available**

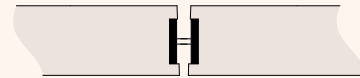

Square edge



Rebated meeting stiles



Rebated meeting stiles and acoustic seals

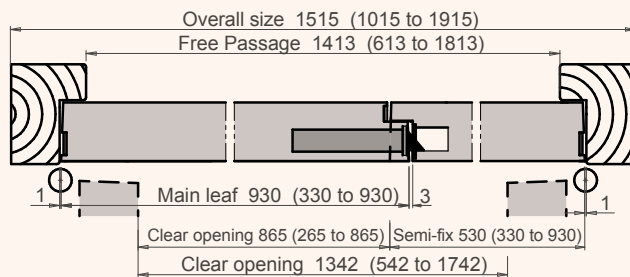
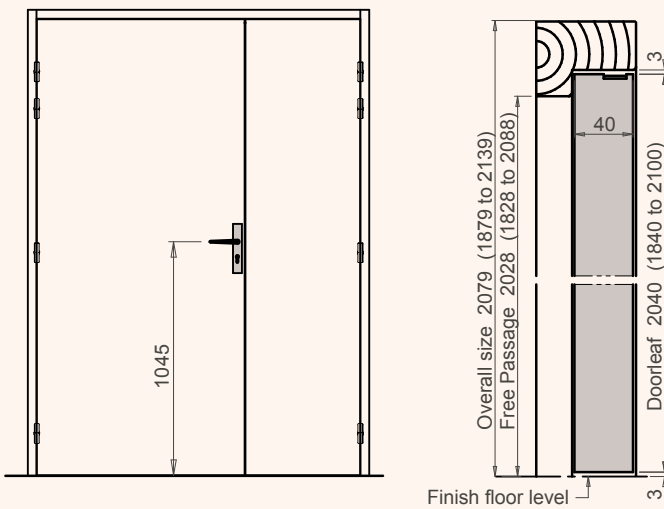
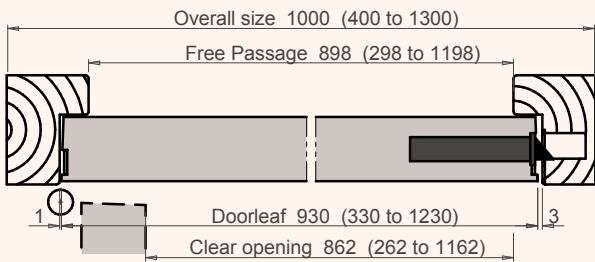

## Timber Fire-rated Door Sets

# EUROFLAM EI30 XXL

(Single and Double Leaf)

### Door Frame

- Hardwood
- Rebated monoblock frame
- Variety of widths
- Extension linings available
- Frame can be lacquered, stained or varnished
- Frame can be wrapped with wood veneer to match door leaf facings

### Choice of Door Facings

- Primed
- Wood veneers
- Laminated
- White paint finish + other colour available by request
- Grooved to a wide choice of standard and bespoke finishes

### Ironmongery

- 4 lift-off hinges - 140 x 70mm mild or stainless steel
- Cut-outs/mortices are available to suit a variety of locks and handles
- Electric striking plate (available on single/double leaf)
- Concealed door closer available: DORMA ITS96
- Factory fitted Emergency exit locks:
  - Vachette D45 emergency exit device
  - Emergency exit push bar selection
- Doors can be held in open position using electro-magnetic device. In the event of a fire, doors will assume closed position

### Perimeter Seals

- Intumescent seals factory fitted (within the frame or leaf)

### Features



**EI30** (FD30)  
(EITHER SIDE – CSTB RS12-109/A –  
CSTB RS12-109/B)

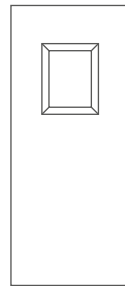

400 x 300

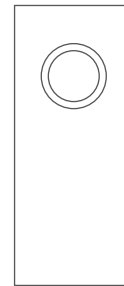

ø360

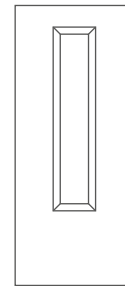

1200 x 200

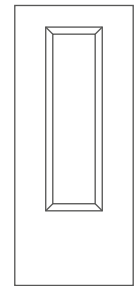

1200 x 300

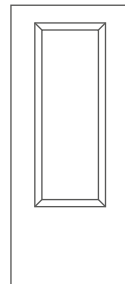

1200 x 400

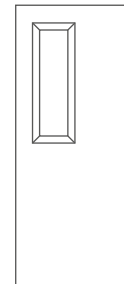

750 x 200

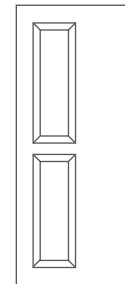

750 x 200  
700 x 200

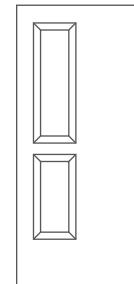

750 x 200  
500 x 200

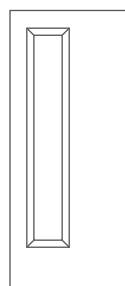

1450 x 200

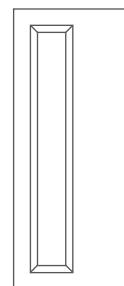

1650 x 200

Technical Details

All sizes are in mm

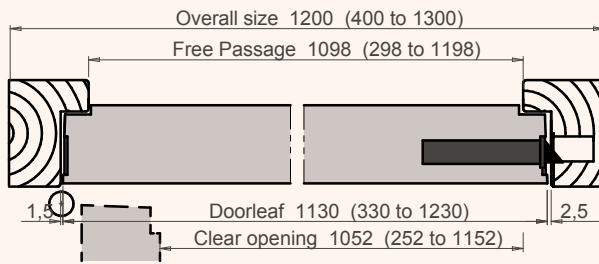
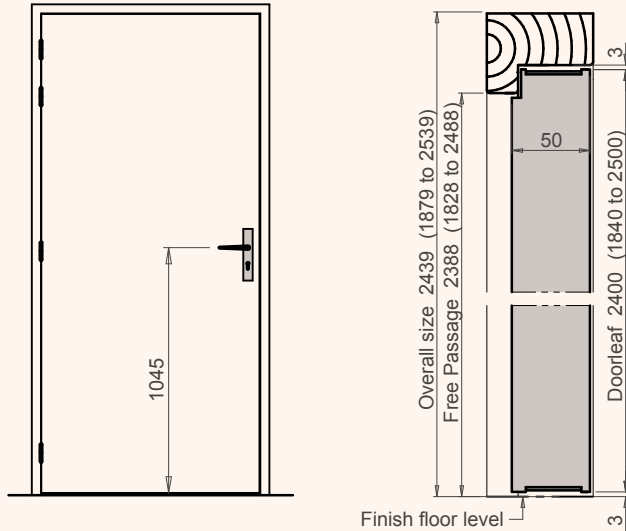

Meeting stiles available

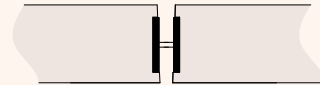

Square edge



Rebated meeting stiles with or without locking device

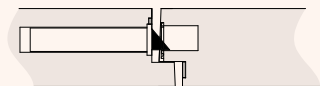

Rebated meeting stiles "Emergency exit" with or without locking device according to EN1125

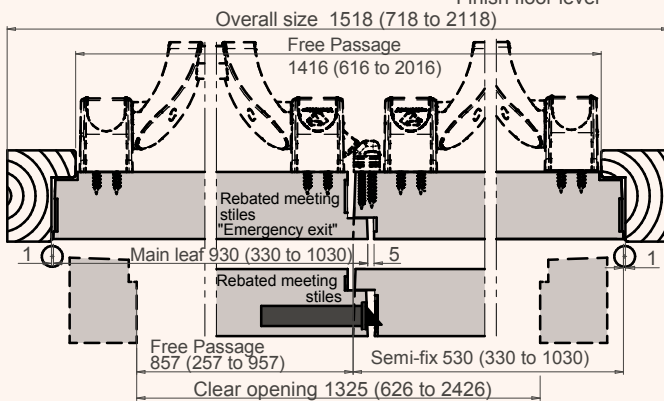
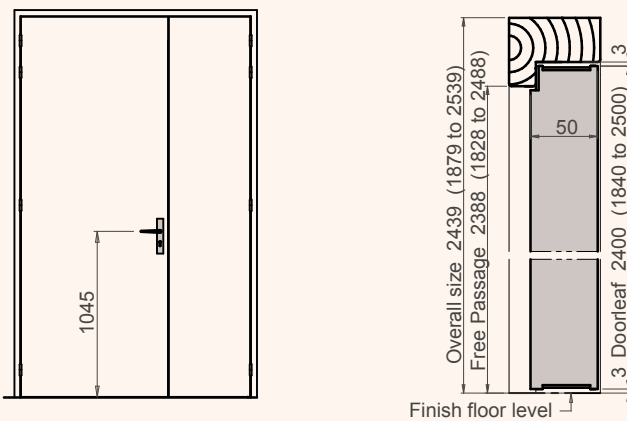

## Timber Fire-rated Door Sets

# EUROFLAM EI60

(Single and Double Leaf)

### Door Leaf

- Huet solid timber core
- Thickness: 51mm hardwood stiles all round

### Door Frame

- Hardwood
- Rebated monoblock frame
- Variety of widths
- Extension linings available
- Frame can be lacquered, stained or varnished
- Frame can be wrapped with wood veneer to match door leaf facings

### Choice of Door Facings

- Primed
- Wood veneers
- Laminated
- White paint finish and other colour available by request
- Grooved to a wide choice of standard and bespoke finishes

### Ironmongery

- 3 or 4 lift-off hinges - 160 x 70mm black or chrome-plated
- Cut-outs/mortices are available to suit a variety of locks and handles
- Cut-outs/mortices are available to suit a large choice of electromagnetic lock
- Spy hole
- Concealed door closer available: DORMA ITS96
- Electric striking plate (available on single leaf)
- Factory fitted Emergency exit locks:
  - Vachette D45 emergency exit device
  - Emergency exit push bar selection
- Doors can be held in open position using electro-magnetic device. In the event of a fire, doors will assume closed position

### Perimeter Seals

- Intumescent seals factory fitted (within the frame or leaf)
- Combined smoke and acoustic seals fitted within the frame and leaf (tested to meet acoustic performance: Rw 35dB single leaf/Rw 34dB double leaf)

### Features



#### EI60

(EITHER SIDE - CS TB RS13-069/A)



**35dB** as single leaf  
**34dB** as double leaf



#### Smoke Seal

(EN 13501-2/ BS EN 1634-3)

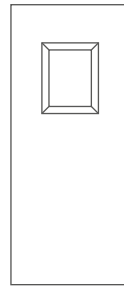

400 x 300

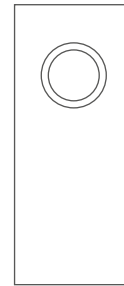

ø360

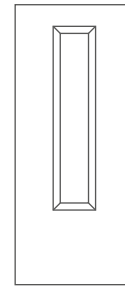

1200 x 200

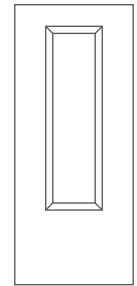

1200 x 300

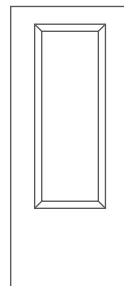

1200 x 400



**Technical Details**

*All sizes are in mm*

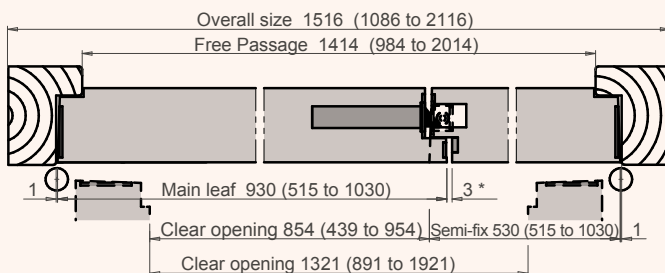
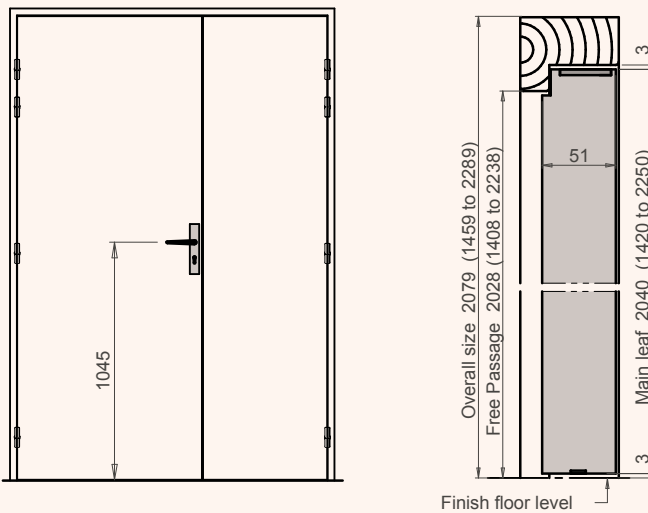
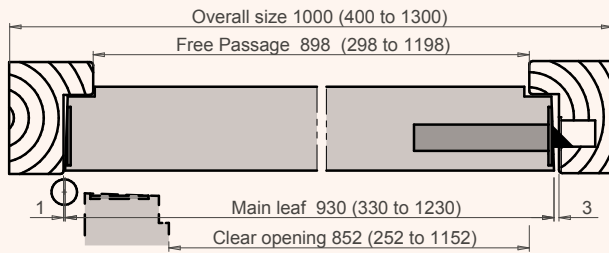
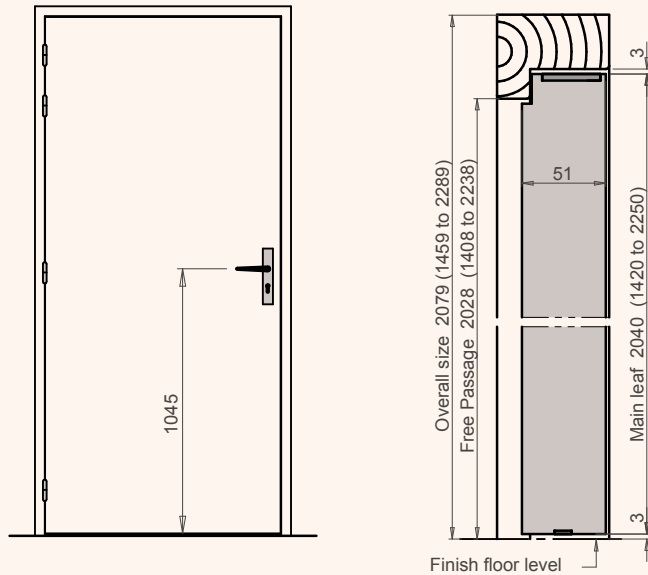

**Meeting stiles available**

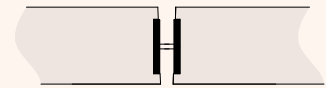

Square edge

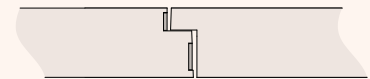

Rebated meeting stiles

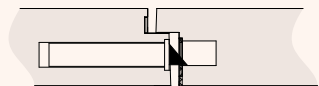

Rebated meeting stiles with or without locking device

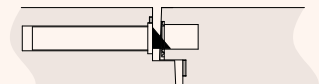

Rebated meeting stiles "Emergency exit" with or without locking device according to EN1125

## Timber Fire-rated Door Sets

# SWINGING EI30

(Single and Double Leaf)

### Door Leaf

- Huet solid timber core
- Thickness: 50mm hardwood stiles all round

### Door Frame

- Hardwood
- Monoblock frame
- Frame can be lacquered, stained or varnished

### Choice of Door Facings

- Primed
- Wood veneers
- Laminated
- White paint finish and other colour available by request
- Grooved to a wide choice of standard and bespoke finishes

### Ironmongery

- Pivot in the upper crosspiece GROOM GRL 100
- Doors can be held in open position using electro-magnetic device (visible or built in the lintel).
- In the event of a fire, doors will assume closed position
- Access control option: Electromagnetic locking system which unlocks in the event of a fire

### Perimeter Seals

- Intumescent seals factory fitted within the frame
- Anti finger trap joint within the frame

### Features



**EI30** (FD30)  
(EITHER SIDE - CSTB RS05.174 - CSTB RS05.173)

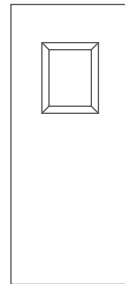

400 x 300

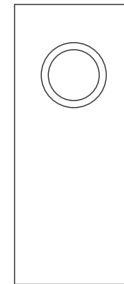

ø360

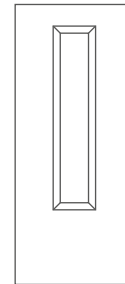

1200 x 200

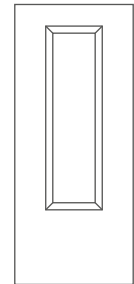

1200 x 300

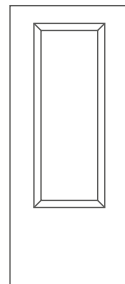

1200 x 400

Technical Details

All sizes are in mm

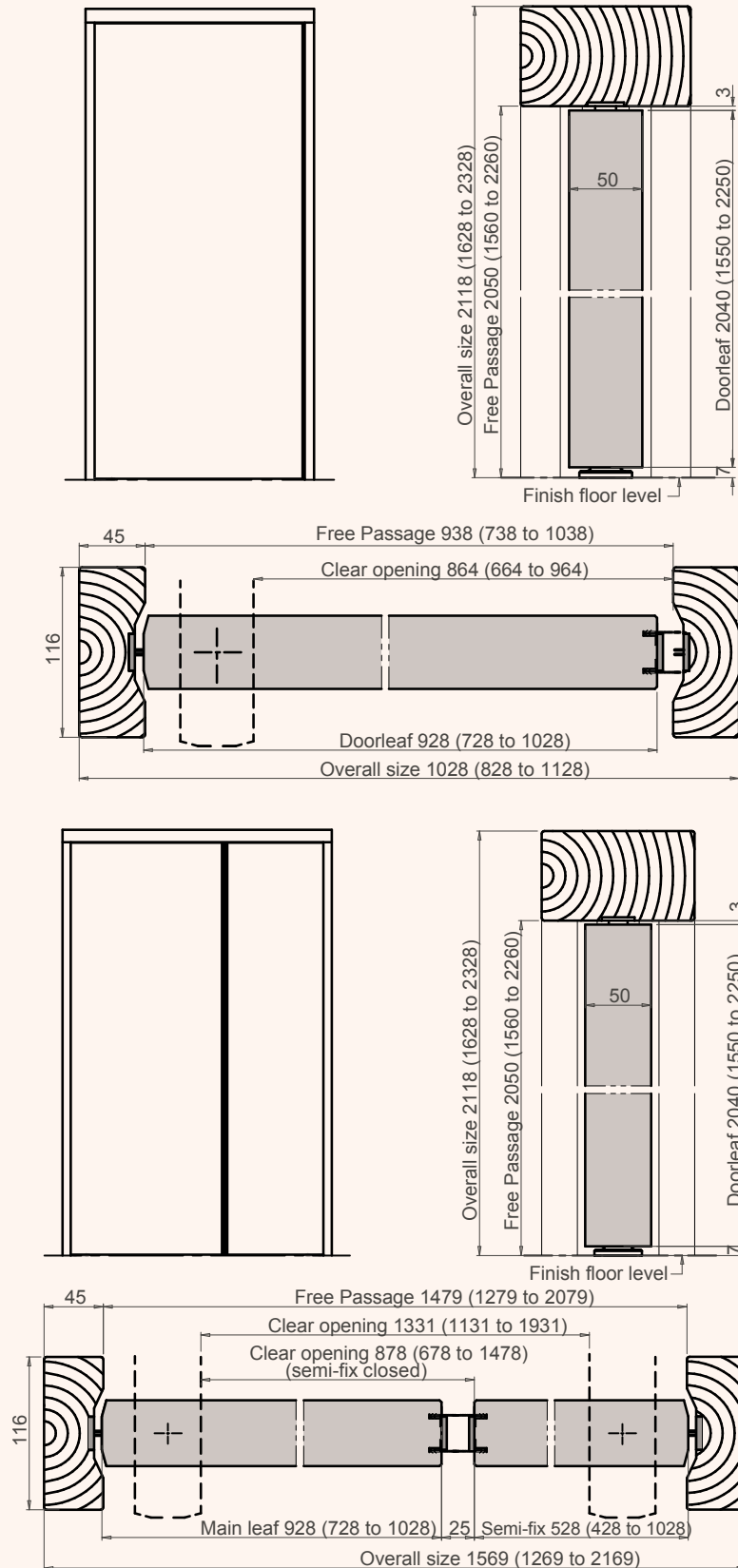

## Timber Fire-rated Door Sets

# SWINGING EI60

(Single and Double Leaf)

### Door Leaf

- Huet solid timber core
- Thickness: 51mm hardwood stiles all round

### Door Frame

- Hardwood
- Monoblock frame
- Frame can be lacquered, stained or varnished

### Choice of Door Facings

- Primed
- Wood veneers
- Laminated
- White paint finish and other colour available by request
- Grooved to a wide choice of standard and bespoke finishes

### Ironmongery

- Pivot in the upper crosspiece GROOM GRL 100
- Doors can be held in open position using electro-magnetic device (visible or built in the lintel).
- In the event of a fire, doors will assume closed position
- Access control option: Electromagnetic locking system which unlocks in the event of a fire

### Perimeter Seals

- Intumescent seals factory fitted within the frame
- Anti finger trap joint within the frame

### Features



**FD60** (FD60)  
(EITHER SIDE - CTICM 06- A-331)

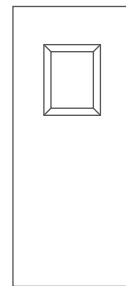

400 x 300

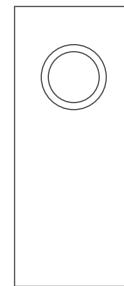

ø360

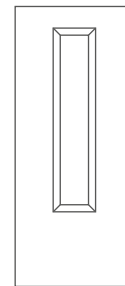

1200 x 200

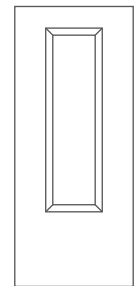

1200 x 300

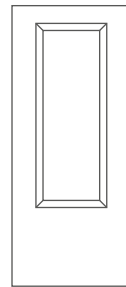

1200 x 400

Technical Details

All sizes are in mm

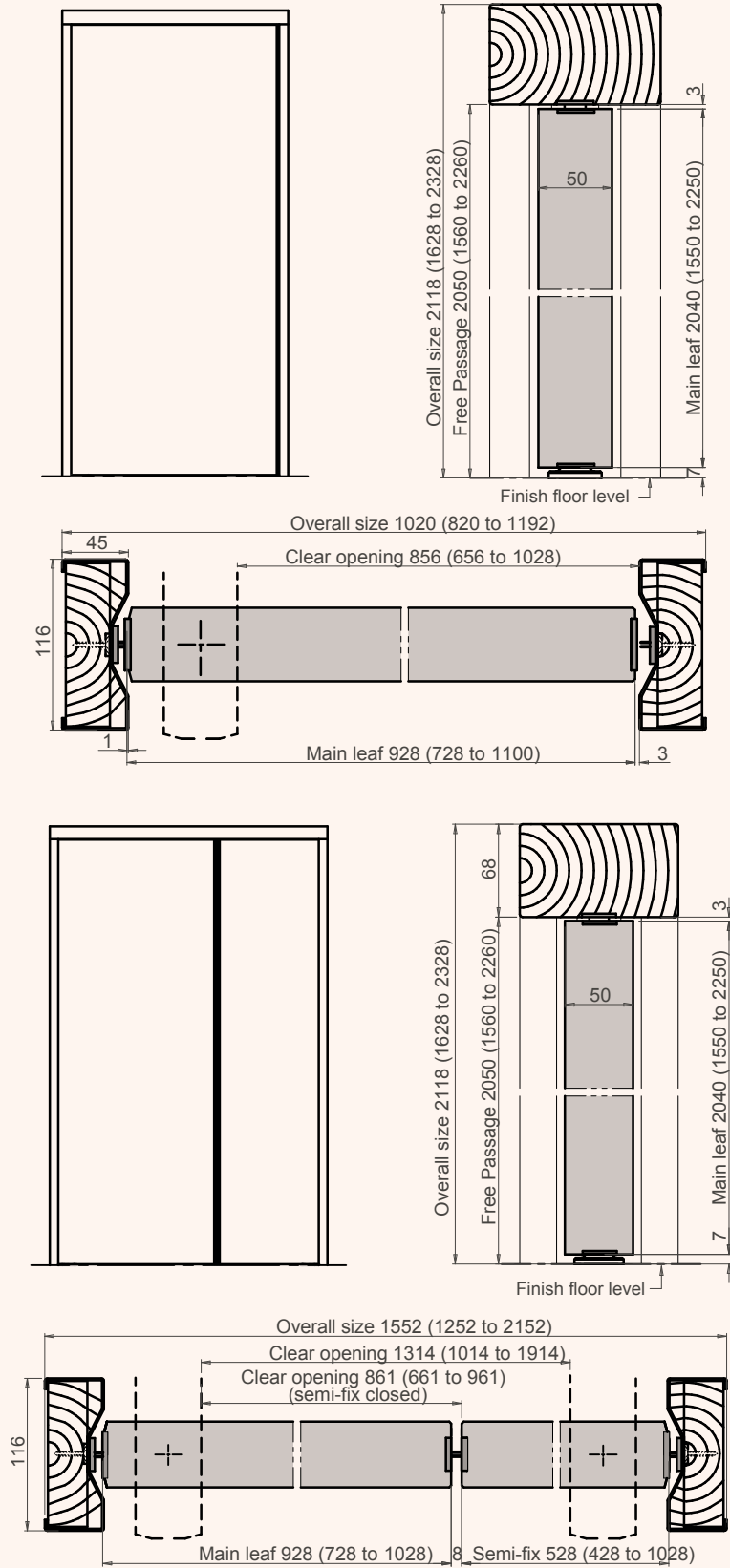

**Timber Acoustic Door Sets**

**CLUB 30**

*(Single and Double Leaf)*

**Door Leaf**

- Huet solid timber core
- Thickness: 40mm hardwood stiles all round

**LIPPINGS**

- Hardwood
- Concealed or exposed rebated lippings

**Door Frame**

- Hardwood
- Rebated monoblock frame
- Variety of widths
- Extension linings available
- Frame can be lacquered, stained or varnished
- Frame can be wrapped with wood veneer to match door leaf facings

**Choice of Door Facings**

- Primed
- Wood veneers
- Laminated
- White paint finish + other colour available by request
- Grooved to a wide choice of standard and bespoke finishes

**Ironmongery**

- 3 or 4 lift-off hinges - 140 x 70mm mild or stainless steel
- Cut-outs/mortices are available to suit a variety of locks and handles
- Cut-outs/mortices are available to suit a large choice of electromagnetic lock
- Spy hole
- Concealed door closer available: DORMA ITS96
- Electric striking plate
- Aluminium protection on lock edge/bottom (single leaf)

**Perimeter Seals**

- Intumescent seals factory fitted (within the frame or leaf)
- Combined smoke and acoustic seals fitted within the frame and leaf
- Large thresholds selection

**Features**



**32dB**

FCBA 404/13/252/1 +ext 372-118/252/1\_e1



**EI30** (FD30)

(EITHER SIDE – CS TB RS 14-009)



**Smoke Seal**

(S<sub>a</sub> Classification)

(EN 13501-2/ BS EN 1634-3)

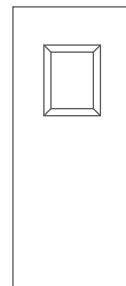

400 x 300

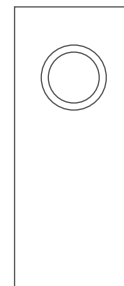

ø360

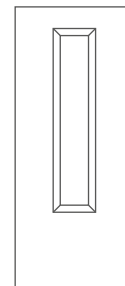

1200 x 200

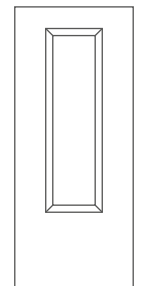

1200 x 300

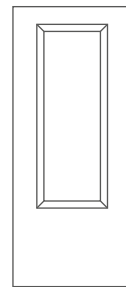

1200 x 400

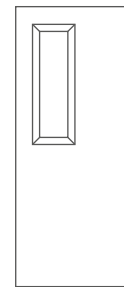

750 x 200

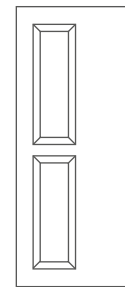

750 x 200  
700 x 200

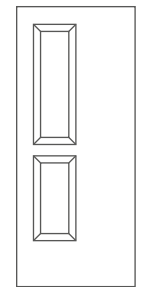

750 x 200  
500 x 200

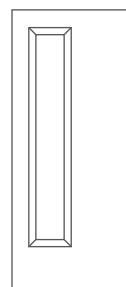

1450 x 200

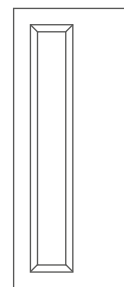

1650 x 200



**Technical Details**

*All sizes are in mm*

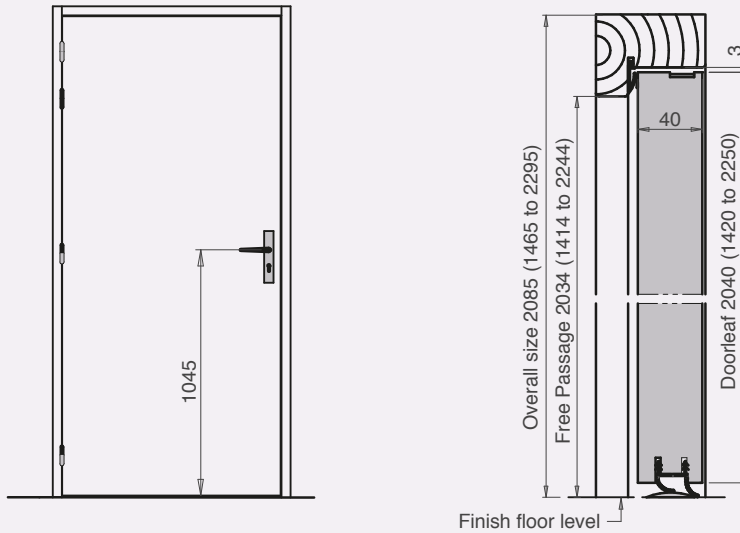

**Swiss threshold 35x20**

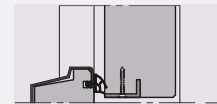

Rw 32 dB

**Swiss threshold 50x20**

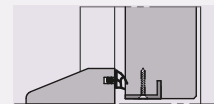

Rw 32 dB

**Swiss threshold 67x27**

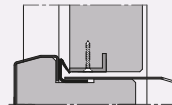

Rw 32 dB

**Pyramidal threshold 67x15**

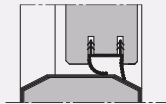

Rw 32 dB

**Flat threshold 35x12**

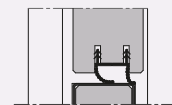

Rw 32 dB

**Swiss threshold 67x19**

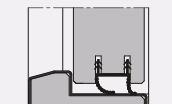

Rw 32 dB

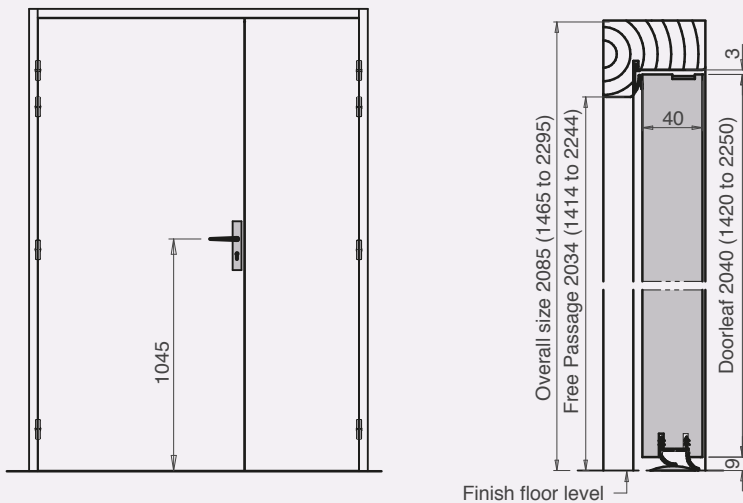
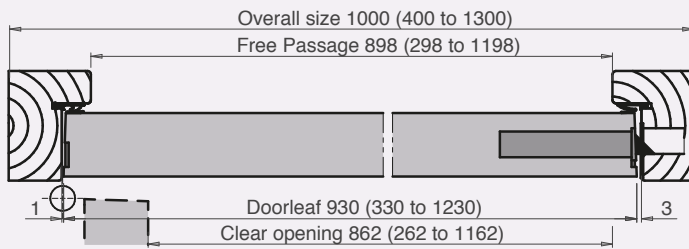

**Mechanical drop seal**

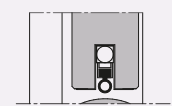

Rw 32 dB

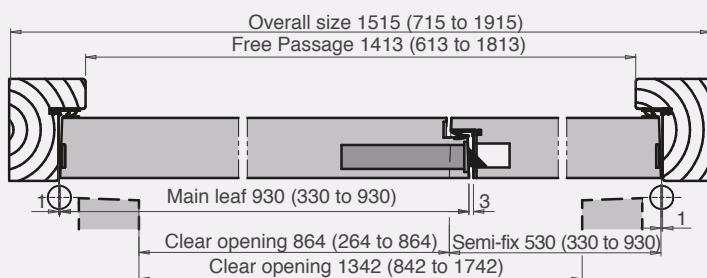

**Timber Acoustic Door Sets**

**CLUB 36**

*(Single and Double Leaf)*

**Door Leaf**

- Huet solid timber core
- Thickness: 40mm hardwood stiles all round

**LIPPINGS**

- Hardwood
- Concealed or exposed rebated lippings

**Door Frame**

- Hardwood
- Rebated monoblock frame
- Variety of widths
- Extension linings available
- Frame can be lacquered, stained or varnished
- Frame can be wrapped with wood veneer to match door leaf facings

**Choice of Door Facings**

- Primed
- Wood veneers
- Laminated
- White paint finish + other colour available by request
- Grooved to a wide choice of standard and bespoke finishes

**Ironmongery**

- 3 or 4 lift-off hinges - 140 x 70mm mild or stainless steel
- Cut-outs/mortices are available to suit a variety of locks and handles
- Cut-outs/mortices are available to suit a large choice of electromagnetic lock
- Spy hole
- Concealed door closer available: DORMA ITS96
- Electric striking plate
- Aluminium protection on lock edge/bottom (single leaf)

**Perimeter Seals**

- Intumescent seals factory fitted (within the frame or leaf)
- Combined smoke and acoustic seals fitted within the frame and leaf
- Large thresholds selection

**Features**



**37dB**

FCBA 404/08/166/5 +ext 372-118/166/5\_e1



**EI30** (FD30)

(EITHER SIDE – CS TB RS 14-010)



**Smoke Seal**

(S<sub>a</sub> Classification)

(EN 13501-2/ BS EN 1634-3)

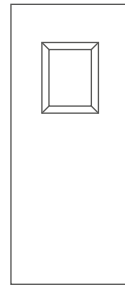

400 x 300

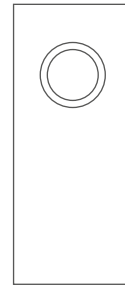

ø360

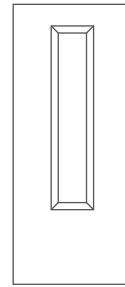

1200 x 200

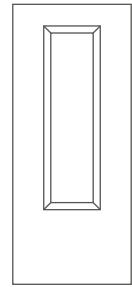

1200 x 300

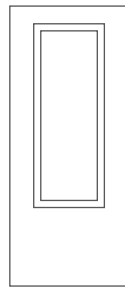

1200 x 400

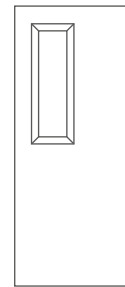

750 x 200

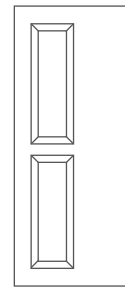

750 x 200  
700 x 200

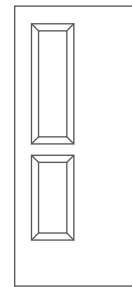

750 x 200  
500 x 200

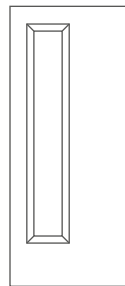

1450 x 200

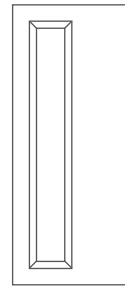

1650 x 200

**Technical Details**

*All sizes are in mm*

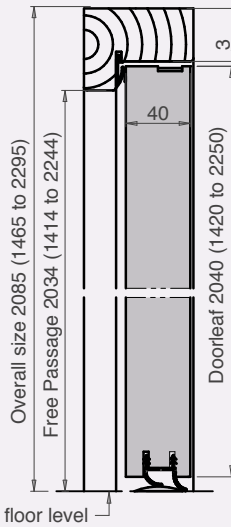
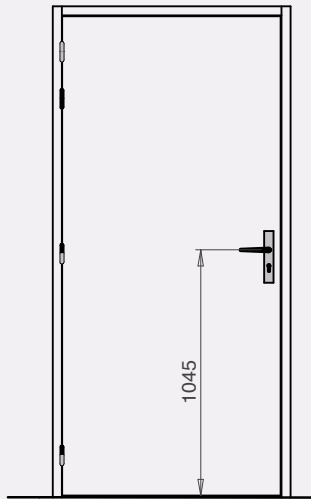

Finish floor level

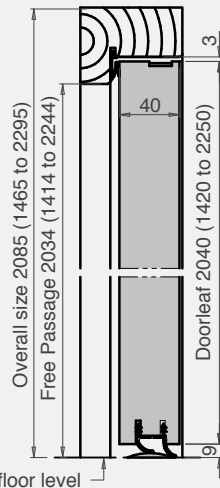
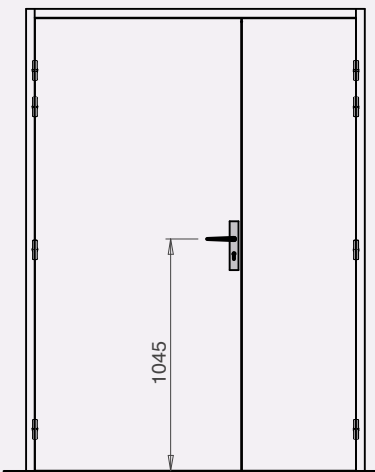
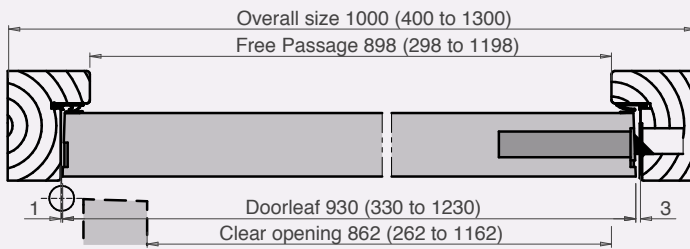

Finish floor level

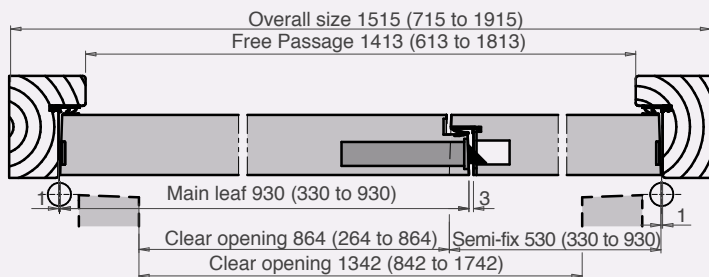

**Swiss threshold 35x20**

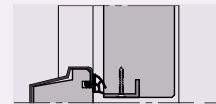

Rw 37 dB

**Swiss threshold 50x20**

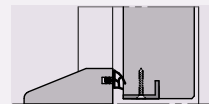

Rw 37 dB

**Swiss threshold 67x27**

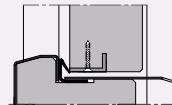

Rw 37 dB

**Pyramidal threshold 67x15**

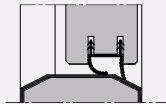

Rw 37 dB

**Flat threshold 35x12**

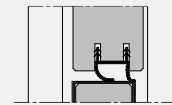

Rw 37 dB

**Swiss threshold 67x19**

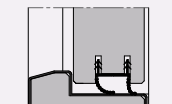

Rw 37 dB

**Mechanical drop seal**

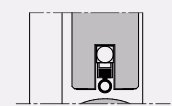

Rw 37 dB

**Timber Acoustic Door Sets**

**CLUB 39**

(Single Leaf)

**Door Leaf**

- Huet solid timber core
- Thickness: 40mm hardwood stiles all round

**LIPPINGS**

- Hardwood
- Concealed or exposed rebated lippings

**Door Frame**

- Hardwood
- Rebated monoblock frame
- Variety of widths
- Extension linings available
- Frame can be lacquered, stained or varnished
- Frame can be wrapped with wood veneer to match door leaf facings

**Choice of Door Facings**

- Primed
- Wood veneers
- Laminated
- White paint finish + other colour available by request
- Grooved to a wide choice of standard and bespoke finishes

**Ironmongery**

- 3 or 4 lift-off hinges - 140 x 70mm mild or stainless steel
- Cut-outs/mortices are available to suit a variety of locks and handles
- Cut-outs/mortices are available to suit a large choice of electromagnetic lock
- Spy hole
- Concealed door closer available: DORMA ITS96
- Electric striking plate
- Aluminium protection on lock edge/bottom (single leaf)

**Perimeter Seals**

- Intumescent seals factory fitted (within the frame or leaf)
- Combined smoke and acoustic seals fitted within the frame and leaf
- Large thresholds selection

**Features**



**41dB**

CSTB 713-940-0087



**EI30 (FD30)**

(EITHER SIDE – BSEN 1634-3 - 2004)



**Smoke Seal**

(S<sub>a</sub> Classification)

(EN 13501-2/ BS EN 1634-3)

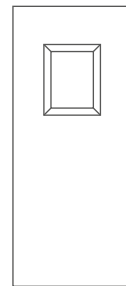

400 x 300

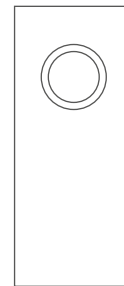

ø360

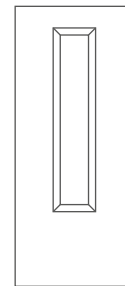

1200 x 200

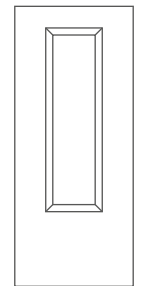

1200 x 300

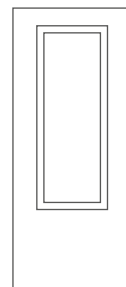

1200 x 400

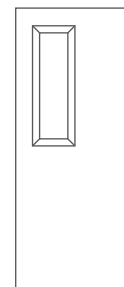

750 x 200

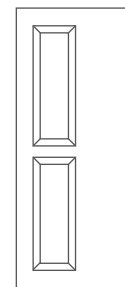

750 x 200  
700 x 200

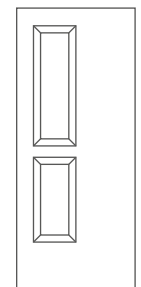

750 x 200  
500 x 200

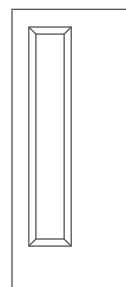

1450 x 200

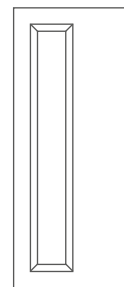

1650 x 200

**Technical Details**

*All sizes are in mm*

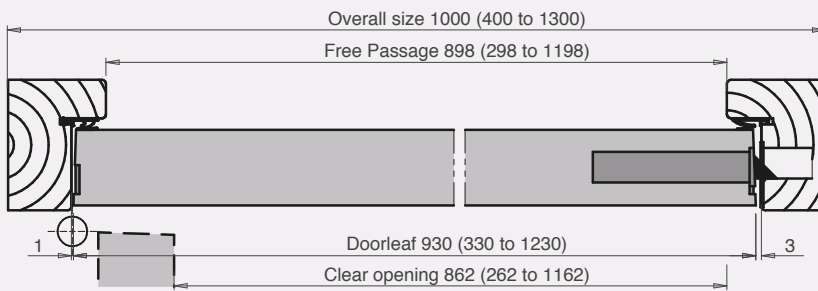
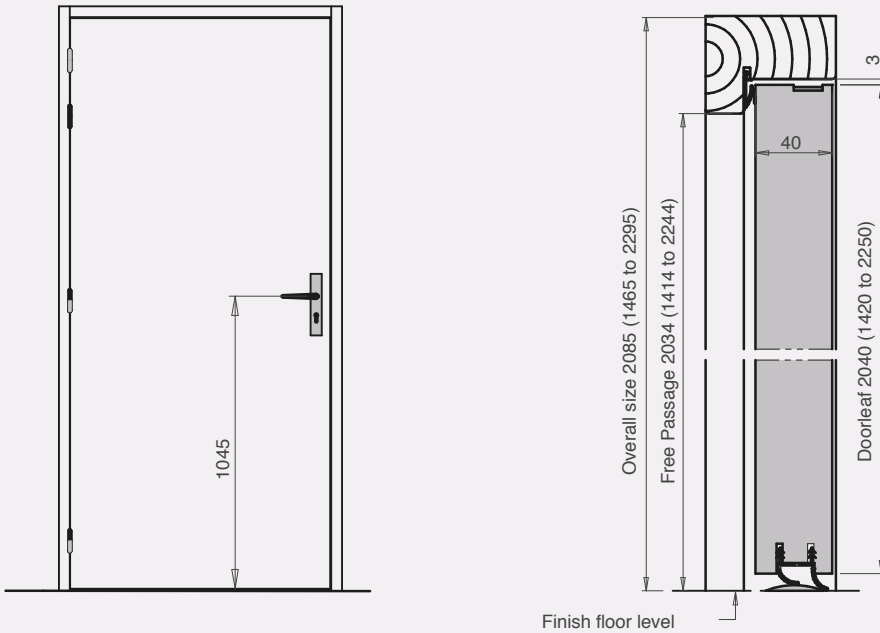

**Swiss threshold 35x20**



Rw 39 dB

**Swiss threshold 50x20**



Rw 39 dB

**Swiss threshold 67x27**

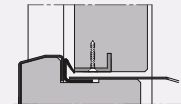

Rw 39 dB

**Pyramidal threshold 67x15**

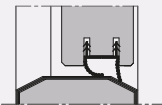

Rw 39 dB

**Flat threshold 35x12**

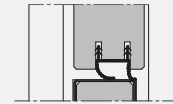

Rw 39 dB

**Swiss threshold 67x19**

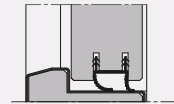

Rw 39 dB

**Mechanical drop seal**

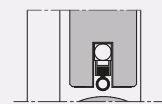

Rw 37 dB

**Timber Acoustic Door Sets**

**CLUB 39**

(Double Leaf)

**Door Leaf**

- Huet solid timber core
- Thickness: 40mm hardwood stiles all round

**Door Frame**

- Hardwood
- Rebated monoblock frame
- Variety of widths
- Extension linings available
- Frame can be lacquered, stained or varnished
- Frame can be wrapped with wood veneer to match door leaf facings

**Choice of Door Facings**

- Primed
- Wood veneers
- Laminated
- White paint finish + other colour available by request
- Grooved to a wide choice of standard and bespoke finishes

**Ironmongery**

- 3 or 4 lift-off hinges - 140 x 70mm mild or stainless steel
- Cut-outs/mortices are available to suit a variety of locks and handles
- Cut-outs/mortices are available to suit a large choice of electromagnetic lock

**Perimeter Seals**

- Intumescent seals factory fitted (within the frame or leaf)
- Combined smoke and acoustic seals fitted within the frame and leaf
- Large thresholds selection

**Features**



**39dB**

FCBA 404/12/296/1 +



**EI30** (FD30)

(EITHER SIDE – CSTB RS 14-011)



**Smoke Seal**

(S<sub>a</sub> Classification)

(EN 13501-2/ BS EN 1634-3)

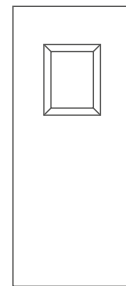

400 x 300

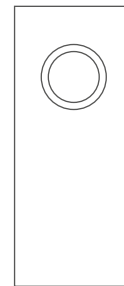

ø360

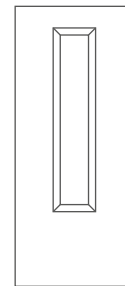

1200 x 200

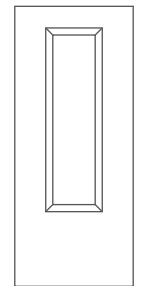

1200 x 300

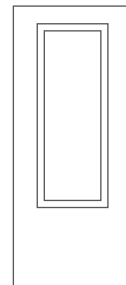

1200 x 400

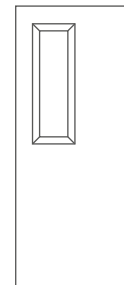

750 x 200

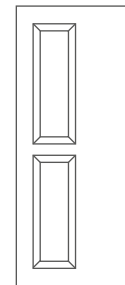

750 x 200  
700 x 200

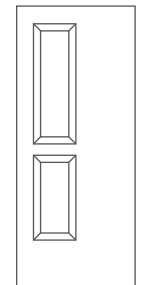

750 x 200  
500 x 200

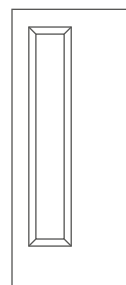

1450 x 200

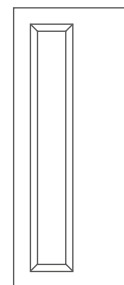

1650 x 200



**Technical Details**

*All sizes are in mm*

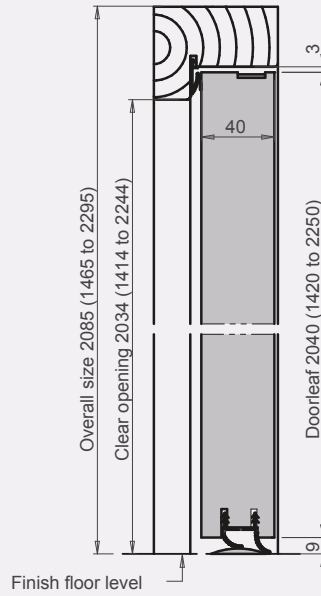
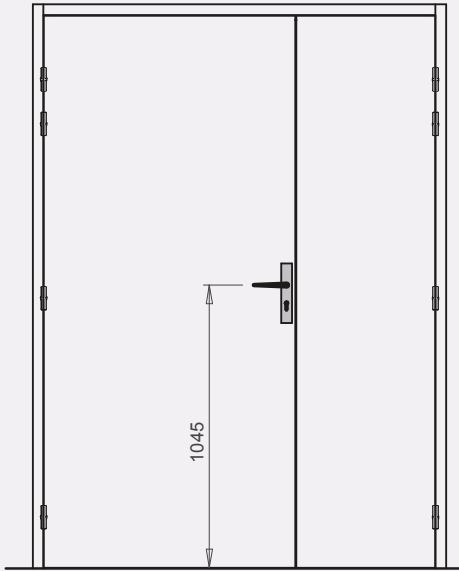

**Swiss threshold 35x20**

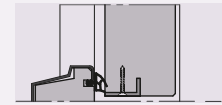

Rw 39 dB

**Swiss threshold 50x20**

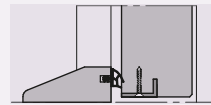

Rw 39 dB

**Swiss threshold 67x27**

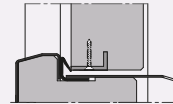

Rw 39 dB

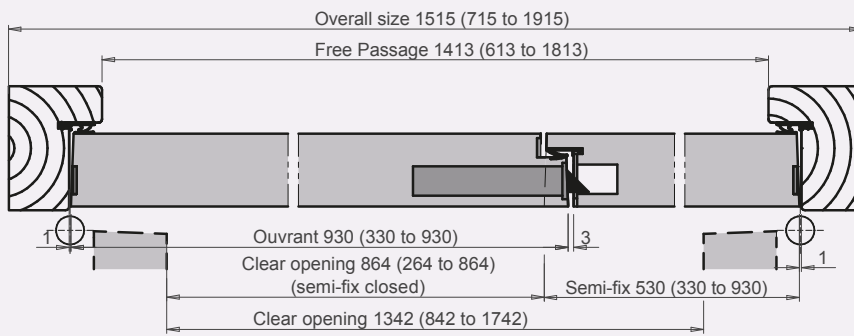

**Pyramidal threshold 67x15**

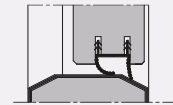

Rw 39 dB

**Flat threshold 35x12**

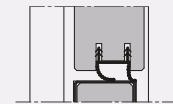

Rw 39 dB

**Swiss threshold 67x19**

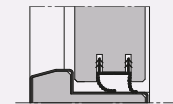

Rw 39 dB

**Mechanical drop seal**

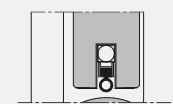

Rw 39 dB

## Timber Acoustic Door Sets

# CLUB 39 INTERCONNECTING DOORSET – SAS52

(Single Leaf)

### Door Leaf

---

- 2 x CLUB 39 EI30 - 41dB doorset back to back
- Huet solid timber core
- Thickness: 40mm hardwood stiles all round

### Lippings

---

- Hardwood
- Concealed or exposed rebated lippings

### Door Frame

---

- Hardwood
- Rebated monoblock frame
- Variety of widths
- Frame can be lacquered, stained or varnished
- Frame can be wrapped with wood veneer to match door leaf facings

### Choice of Door Facings

---

- Primed
- Wood veneers
- Laminated
- White paint finish + other colour available by request
- Grooved to a wide choice of standard and bespoke finishes

### Ironmongery

---

- 3 or 4 lift-off hinges - 140 x 70mm mild or stainless steel
- Cut-outs/mortices are available to suit a variety of locks and handles

### Perimeter Seals

---

- Intumescent seals factory fitted (within the frame or leaf)
- Combined smoke and acoustic seals fitted within the frame and leaf
- Flat threshold 35 x 12mm

### Features

---



**55dB**  
CSTB 31629



**EI30** (FD30)  
(EITHER SIDE)



**Smoke Seal**  
(S<sub>a</sub> Classification)  
(EN 13501-2/ BS EN 1634-3)

Technical Details

All sizes are in mm

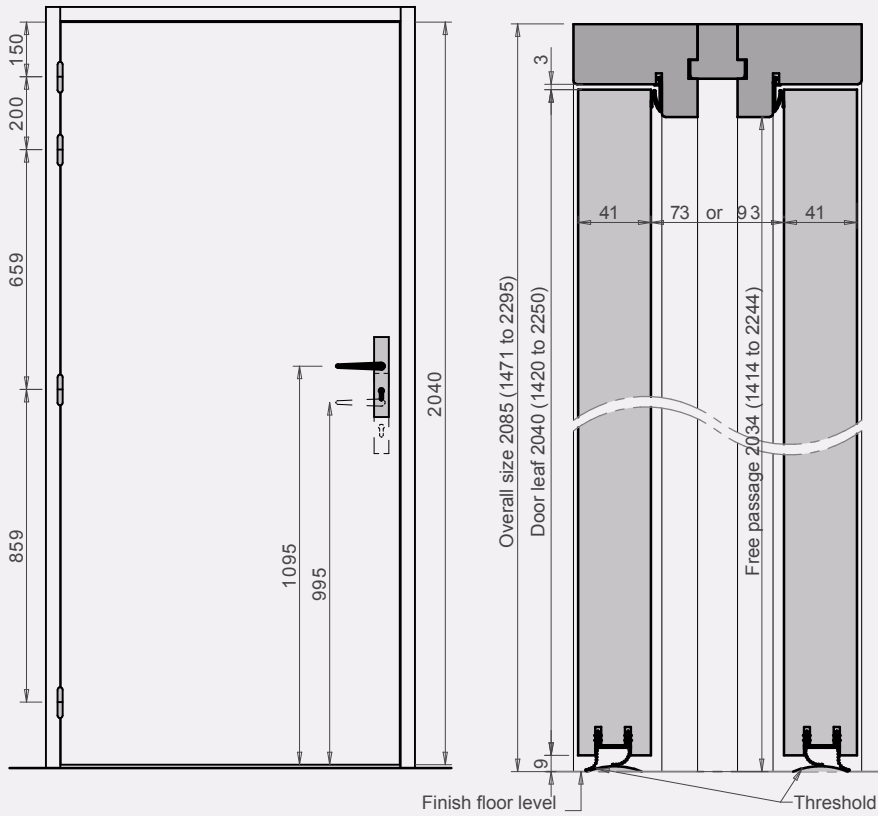

Flat threshold 35x12

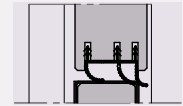

Rw 55 dB



**Timber Acoustic Door Sets**

**CHORUS 39**

(Single Leaf)

**Door Leaf**

- Huet multi-layer acoustic core
- Thickness: 40mm hardwood stiles all round
- High stability leaf due to the inclusion of 2 steel sheets

**Door Frame**

- Hardwood/softwood
- Rebated monoblock frame
- Variety of widths
- Extension linings available
- Frame can be lacquered, stained or varnished
- Frame can be wrapped with wood veneer to match door leaf facings

**Choice of Door Facings**

- Primed
- Wood veneers
- Laminated
- White paint finish + other colour available by request
- Grooved to a wide choice of standard and bespoke finishes

**Ironmongery**

- 4 lift-off hinges - 140 x 70mm mild or stainless steel
- Cut-outs/mortices are available to suit a variety of locks and handles
- Cut-outs/mortices are available to suit a large choice of electromagnetic lock
- Spy hole
- Concealed door closer available: DORMA ITS96
- Electric striking plate (available on single leaf)
- Aluminium protection on lock edge/bottom

**Perimeter Seals**

- Intumescent seals factory fitted (within the frame or leaf)
- Combined smoke and acoustic seals fitted within the frame and leaf
- Large thresholds selection

**Features**



**39dB**  
(FCBA 404/07/101/13)



**EI30** (FD30)  
(EITHER SIDE – CSTB RS 14-011)



**3c Stability\***  
(NF EN 12219)



**Smoke Seal**  
(S<sub>a</sub> Classification)  
(EN 13501-2/ BS EN 1634-3)

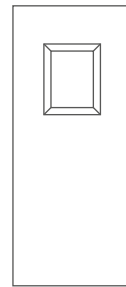

400 x 300

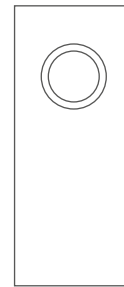

ø360

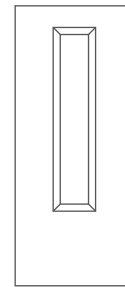

1200 x 200

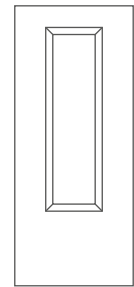

1200 x 300

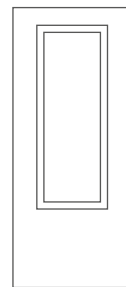

1200 x 400

\*Stability of the door leaf is an important factor, particularly in areas of temperature variance between rooms or between rooms and corridors. Any distortion of the door leaf will result in the seals not functioning correctly. With the inclusion of a minimum of 2 steel sheets and other materials, Huet door leaves offer less than 2mm of distortion. The result is a door leaf and seal which continues to perform even with wide temperature differences.

**Technical Details**

*All sizes are in mm*

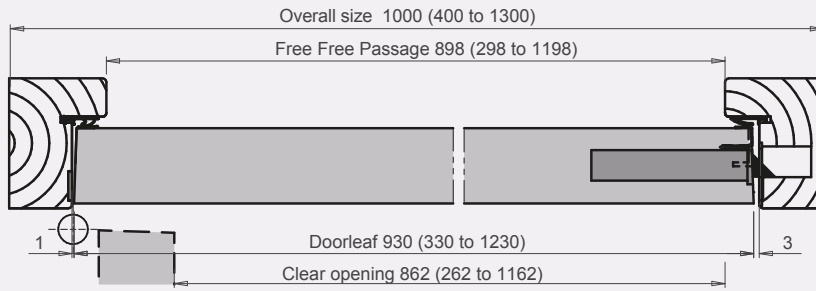
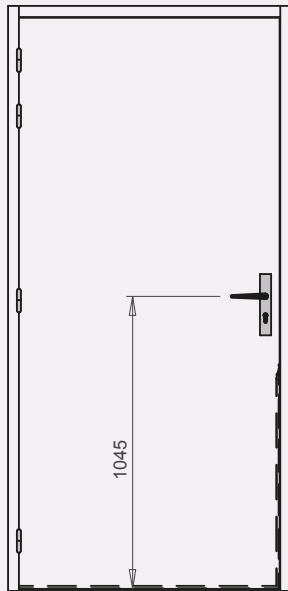

**Swiss threshold 35x20**



Rw 39 dB

**Swiss threshold 50x20**

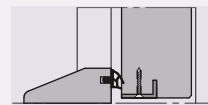

Rw 39 dB

**Swiss threshold 67x27**



Rw 39 dB

**Pyramidal threshold 67x15**

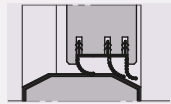

Rw 39 dB

**Flat threshold 35x12**

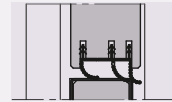

Rw 39 dB

**Swiss threshold 67x19**

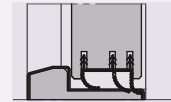

Rw 39 dB

**Mechanical drop seal**

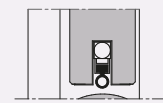

Rw 37 dB

**Timber Acoustic Door Sets**

**CHORUS 42**

*(Single and Double Leaf)*

**Door Leaf**

- Huet multi-layer acoustic core
- Thickness: 40mm hardwood stiles all round
- High stability leaf due to the inclusion of 2 steel sheets

**Door Frame**

- Hardwood
- Rebated monoblock frame
- Variety of widths
- Extension linings available
- Frame can be lacquered, stained or varnished
- Frame can be wrapped with wood veneer to match door leaf facings

**Choice of Door Facings**

- Primed
- Wood veneers
- Laminated
- White paint finish + other colour available by request
- Grooved to a wide choice of standard and bespoke finishes

**Ironmongery**

- 4 lift-off hinges - 140 x 70mm mild or stainless steel
- Cut-outs/mortices are available to suit a variety of locks and handles
- Cut-outs/mortices are available to suit a large choice of electromagnetic lock
- Spy hole
- Concealed door closer available: DORMA ITS96
- Electric striking plate (available on single leaf)
- Aluminium protection on lock edge/bottom

**Perimeter Seals**

- Intumescent seals factory fitted (within the frame or leaf)
- Combined smoke and acoustic seals fitted within the frame and leaf
- Large thresholds selection

**Features**



**42dB**  
(NF EN ISO 140-3/NF EN ISO 717-1)



**EI30 (FD30)**  
(EITHER SIDE – BN EN 1634-1)



**3c Stability\***  
(NF EN 12219)



**Smoke Seal**  
(S<sub>a</sub> Classification)  
(EN 13501-2/ BS EN 1634-3)

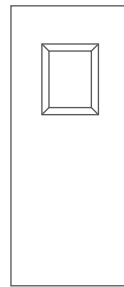

400 x 300

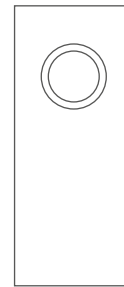

ø360

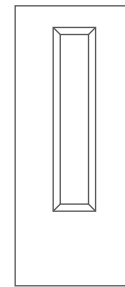

1200 x 200

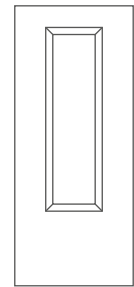

1200 x 300

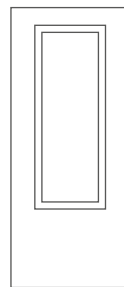

1200 x 400

\*Stability of the door leaf is an important factor, particularly in areas of temperature variance between rooms or between rooms and corridors. Any distortion of the door leaf will result in the seals not functioning correctly. With the inclusion of a minimum of 2 steel sheets and other materials, Huet door leaves offer less than 2mm of distortion. The result is a door leaf and seal which continues to perform even with wide temperature differences.



**Technical Details**

*All sizes are in mm*

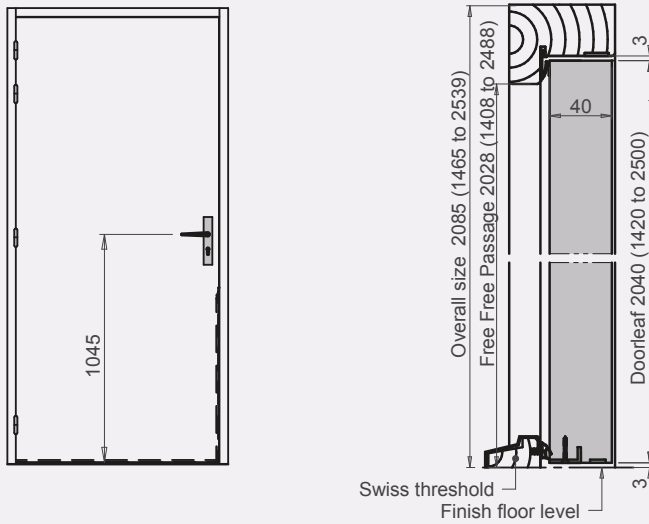

**Swiss threshold 35x20**



Rw 42 dB

**Swiss threshold 50x20**

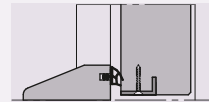

Rw 42 dB

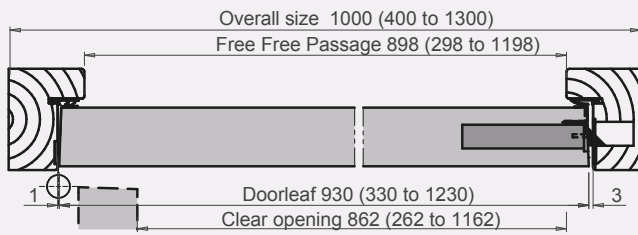

**Swiss threshold 67x27**

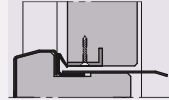

Rw 42 dB

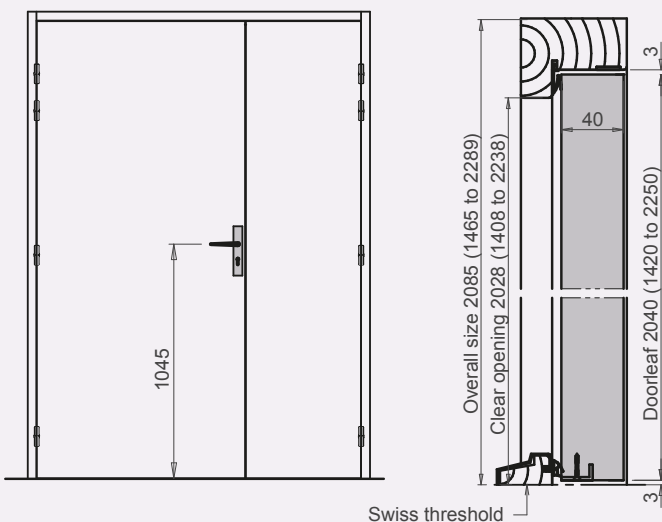

**Pyramidal threshold 67x15**

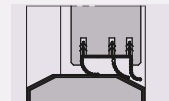

Rw 41dB

**Flat threshold 35x12**

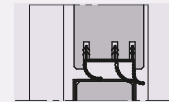

Rw 41dB

**Swiss threshold 67x19**

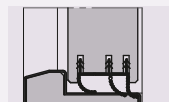

Rw 41dB

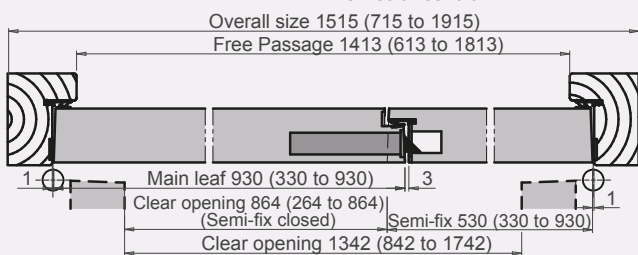

**Mechanical drop seal**

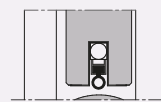

Rw 41 dB

## Timber Acoustic Door Sets

# CHORUS 46

(Single and Double Leaf)

### Door Leaf

- Huet multi-layer acoustic core
- Thickness: 51mm hardwood stiles all round
- High stability leaf due to the inclusion of 2 steel sheets

### Door Frame

- Hardwood
- Rebated monoblock frame
- Variety of widths
- Extension linings available
- Frame can be lacquered, stained or varnished
- Frame can be wrapped with wood veneer to match door leaf facings

### Choice of Door Facings

- Primed
- Wood veneers
- Laminated
- White paint finish + other colour available by request
- Grooved to a wide choice of standard and bespoke finishes

### Ironmongery

- 4 lift-off hinges - 160 x 70mm black or stainless steel
- Cut-outs/mortices are available to suit a variety of locks and handles
- Cut-outs/mortices are available to suit a large choice of electromagnetic lock
- Spy hole
- Concealed door closer available: DORMA ITS96
- Electric striking plate (available on single leaf)

### Perimeter Seals

- Intumescent seals factory fitted (within the frame and leaf)
- Combined smoke and acoustic seals fitted within the frame and leaf
- Large thresholds selection

### Features



**46dB**

(FCBA 404-07-101-7)



**EI30** (FD30)

(EITHER SIDE – CSTB RS14-089)



**3c Stability\***



**Smoke Seal**

(S<sub>a</sub> Classification)

(EN 13501-2/ BS EN 1634-3)

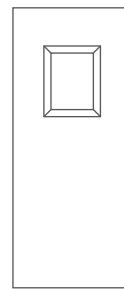

400 x 300

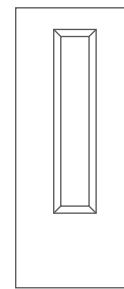

1200 x 200

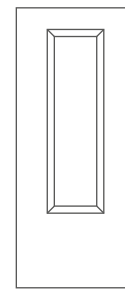

1200 x 300

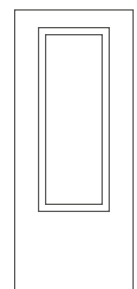

1200 x 400

\*Stability of the door leaf is an important factor, particularly in areas of temperature variance between rooms or between rooms and corridors. Any distortion of the door leaf will result in the seals not functioning correctly. With the inclusion of a minimum of 2 steel sheets and other materials, Huet door leaves offer less than 2mm of distortion. The result is a door leaf and seal which continues to perform even with wide temperature differences.

**Technical Details**

*All sizes are in mm*

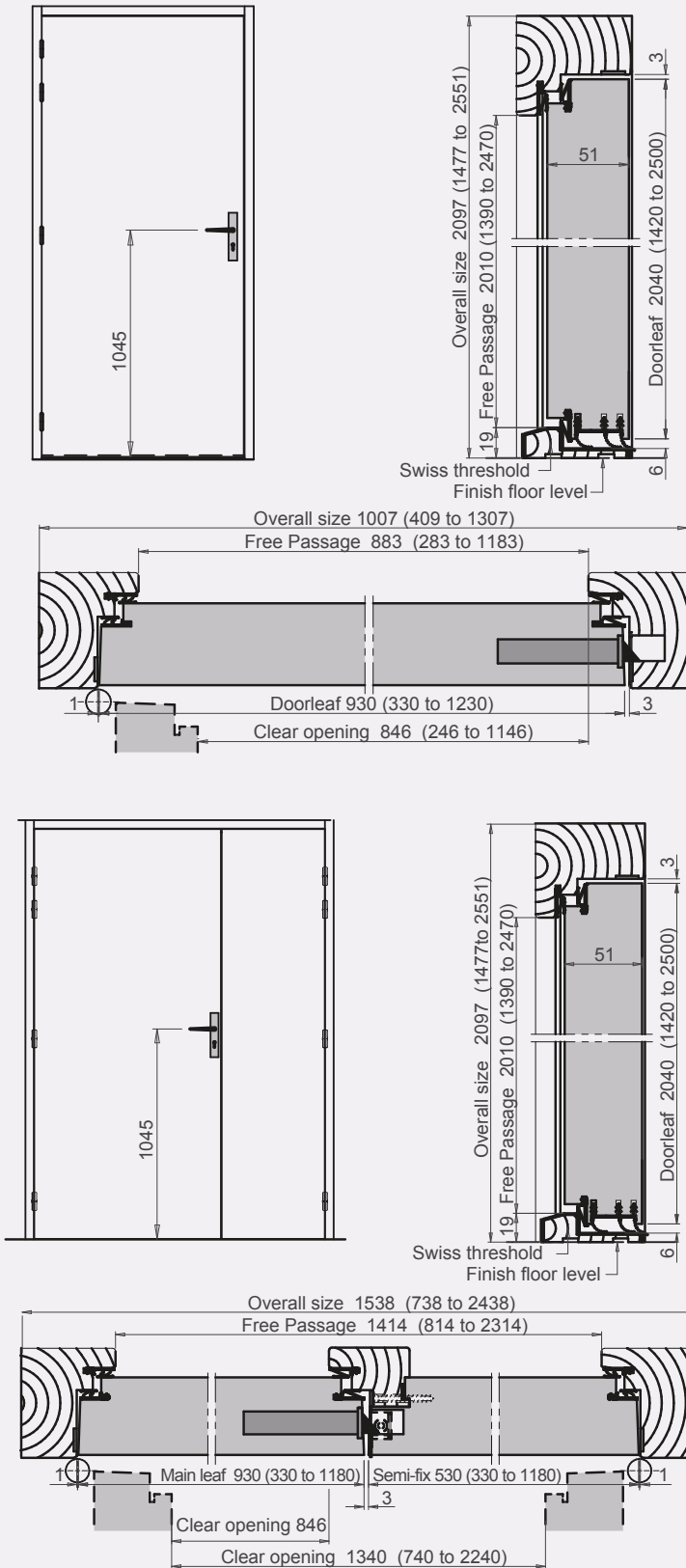

**Swiss threshold 35x20**

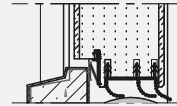

Rw 46 dB

**Swiss threshold 50x20**

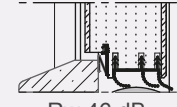

Rw 46 dB

**Swiss threshold 67x19**

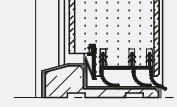

Rw 46 dB

**Pyramidal threshold 67x15**

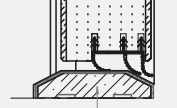

Rw 46 dB

**Flat threshold 35x12**

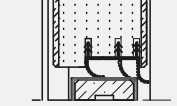

Rw 46 dB

**Lip seal**

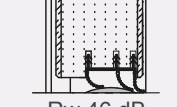

Rw 46 dB

## Timber Acoustic Door Sets

# CHORUS 49

(Single and Double Leaf)

### Door Leaf

- Huet multi-layer acoustic core
- Thickness: 84mm hardwood stiles all round
- High stability leaf due to the inclusion of 4 steel sheets

### Door Frame

- Hardwood
- Rebated monoblock frame
- Variety of widths
- Extension linings available
- Frame can be lacquered, stained or varnished
- Frame can be wrapped with wood veneer to match door leaf facings

### Choice of Door Facings

- Primed
- Wood veneers
- Laminated
- White paint finish + other colour available by request
- Grooved to a wide choice of standard and bespoke finishes

### Ironmongery

- 4 lift-off ball bearing hinges - 190 x 80mm black
- Cut-outs/mortices are available to suit a variety of locks and handles
- Electric striking plate (available on single leaf)

### Perimeter Seals

- Intumescent seals factory fitted (within the frame and leaf)
- Combined smoke and acoustic seals fitted within the frame and leaf
- Large thresholds selection

### Features



**48dB**

(FCBA 404-14-190)



**EI30** (FD30)

(EITHER SIDE – CSTB RS14-090)



**3c Stability\***



**Smoke Seal**

(S<sub>a</sub> Classification)

(EN 13501-2/ BS EN 1634-3)

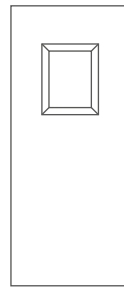

400 x 300

\*Stability of the door leaf is an important factor, particularly in areas of temperature variance between rooms or between rooms and corridors. Any distortion of the door leaf will result in the seals not functioning correctly. With the inclusion of a minimum of 2 steel sheets and other materials, Huet door leaves offer less than 2mm of distortion. The result is a door leaf and seal which continues to perform even with wide temperature differences.

**Technical Details**

*All sizes are in mm*

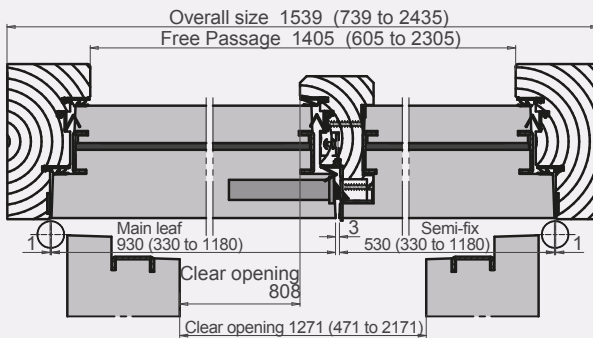
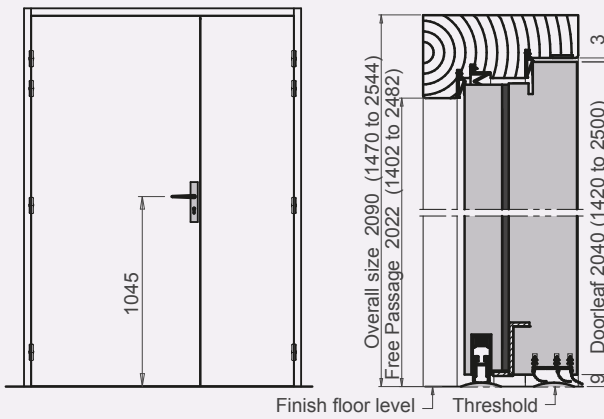
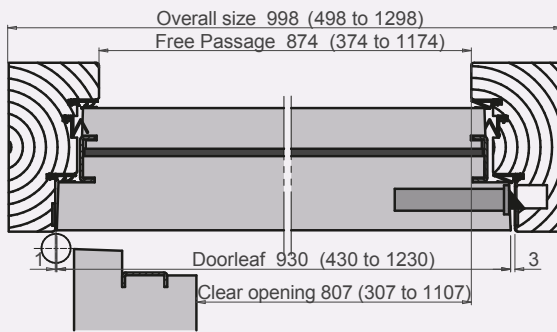
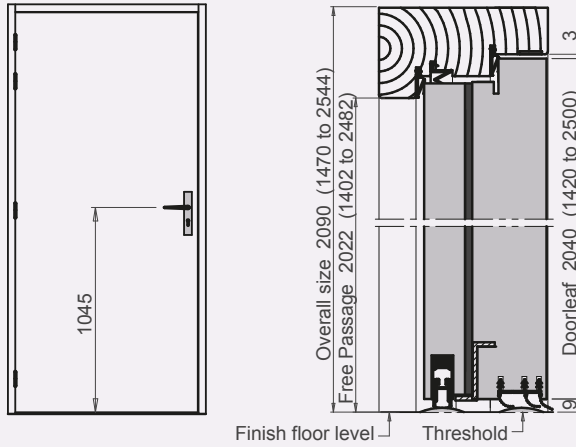

**Pyramidal threshold 95x15**

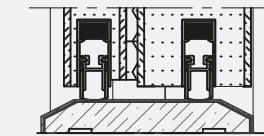

Rw 48 dB

**Mechanical drop seals**

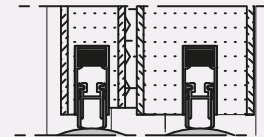

Rw 48 dB

**Flat threshold 80x12**

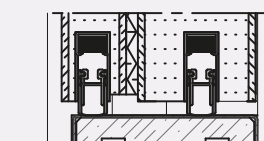

Rw 48 dB

**Lip seal**

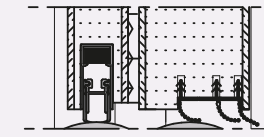

Rw 48 dB

**Flat threshold 80x12**

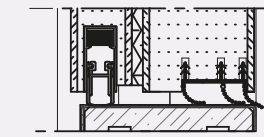

Rw 48 dB

**Pyramidal threshold 95x15**

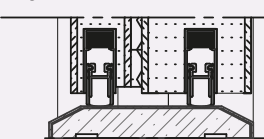

Rw 48 dB

**Timber Acoustic Door Sets**

**EUROFLAM EI60 35**

*(Single and Double Leaf)*

**Door Leaf**

- Huet solid timber core.
- Thickness: 51mm hardwood stiles all round

**Door Frame**

- Hardwood
- Rebated monoblock frame
- Variety of widths
- Extension linings available
- Frame can be lacquered, stained or varnished
- Frame can be wrapped with wood veneer to match
- door leaf facings

**Choice of Door Facings**

- Primed
- Wood veneers
- Laminated
- White paint finish + other colour available by request
- Grooved to a wide choice of standard and bespoke finishes

**Ironmongery**

- 3 or 4 lift-off hinges - 160 x 70mm black or chrome-plated
- Cut-outs/mortices are available to suit a variety of locks and handles
- Cut-outs/mortices are available to suit a large choice of electromagnetic lock
- Spy hole
- Concealed door closer available: DORMA ITS96
- Electric striking plate (available on single leaf)
- Factory fitted Emergency exit locks:
  - Vachette D45 emergency exit device
  - Emergency exit push bar selection
- Doors can be held in open position using electro-magnetic device. In the event of a fire, doors will assume closed position

**Perimeter Seals**

- Intumescent seals factory fitted (within the frame or leaf)
- Combined smoke and acoustic seals fitted within the frame and leaf (tested to meet acoustic performance:
  - Rw 35dB single leaf/Rw 34dB double leaf)

**Features**



**EI60** (FD60)  
(EITHER SIDE - CS TB RS13-069/A)



**35dB** as single leaf  
**34dB** as double leaf



**Smoke Seal** (S, Classification)  
(EN 13501-2/ BS EN 1634-3)

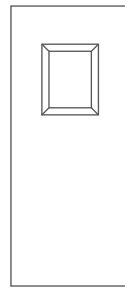

400 x 300

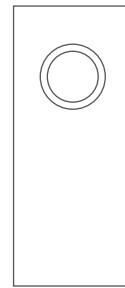

360

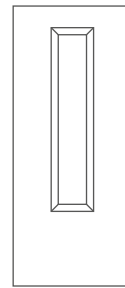

1200 x 200

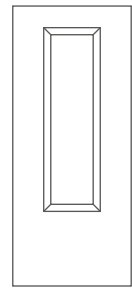

1200 x 200

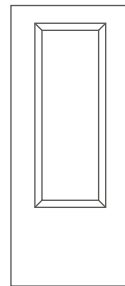

1200 x 400

Technical Details

All sizes are in mm

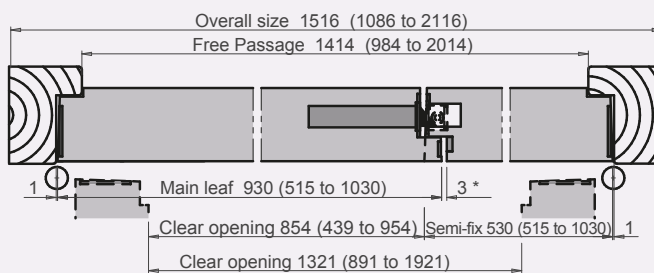
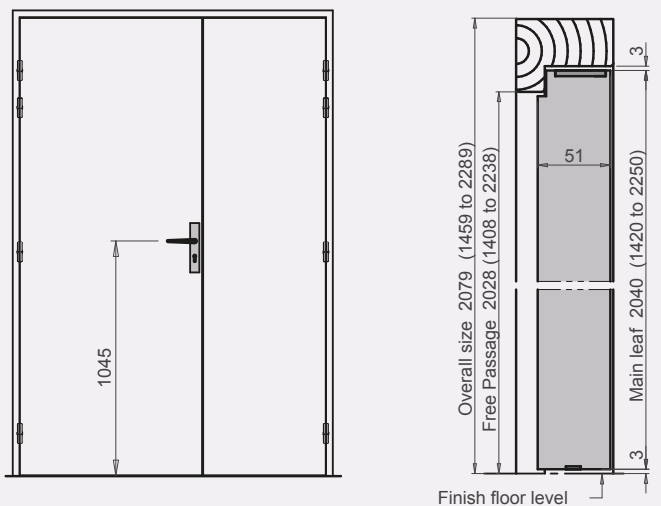
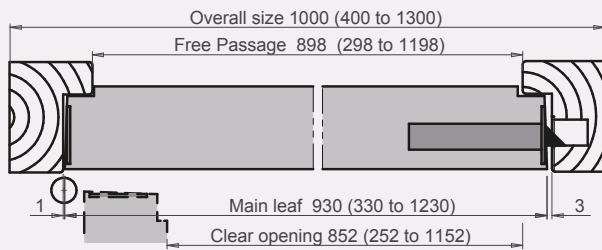
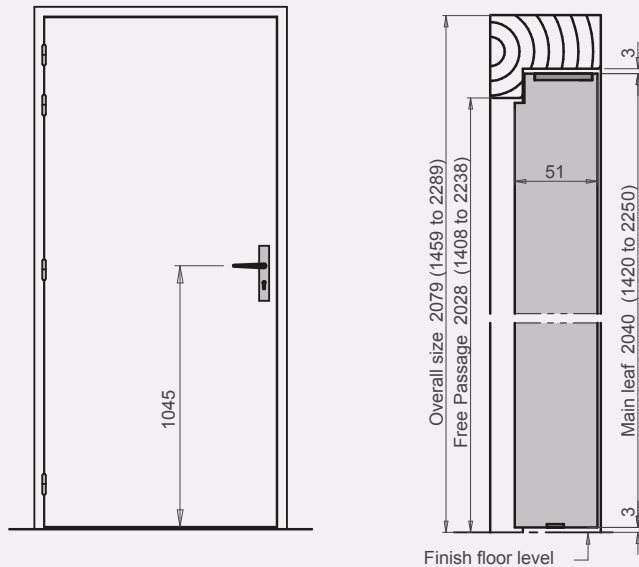

Meeting stiles available

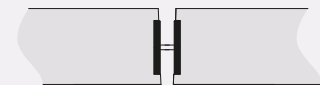

Square edge

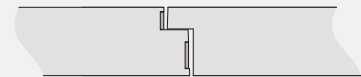

Rebated meeting stiles

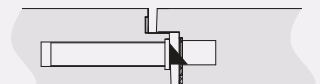

Rebated meeting stiles with or without locking device

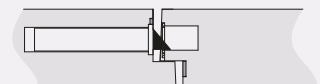

Rebated meeting stiles "Emergency exit" with or without locking device according to EN1125



## Timber and Acoustic Door Sets

# ISADX 3960

(Single and Double Leaf)

### Door Leaf

- Huet multi-layer acoustic core
- Thickness: 64mm hardwood stiles all round
- High stability leaf due to the inclusion of 2 steel sheets

### Door Frame

- Hardwood
- Rebated monoblock frame
- Variety of widths
- Extension linings available
- Frame can be lacquered, stained or varnished
- Frame can be wrapped with wood veneer to match door leaf facings

### Choice of Door Facings

- Primed
- Wood veneers
- Laminated
- White paint finish + other colour available by request
- Grooved to a wide choice of standard and bespoke finishes

### Ironmongery

- 4 lift-off hinges - 160 x 90mm black or chrome plated
- Cut-outs/mortices are available to suit a variety of locks and handles
- Cut-outs/mortices are available to suit a large choice of electromagnetic lock
- Spy hole
- Concealed door closer available: DORMA ITS96

### Perimeter Seals

- Intumescent seals factory fitted (within the frame and leaf)
- Combined smoke and acoustic seals fitted within the frame
- Thresholds selection

### Features



**39dB**

(CSTB 713-970-0025 - CSTB AC97-052)



**EI60** (FD60)

(EITHER SIDE – According to BS EN 1634-1:2000)



**3c Stability\***

(NF EN 12219)



**Smoke Seal**

(S<sub>a</sub> Classification)  
(EN 13501-2/ BS EN 1634-3)

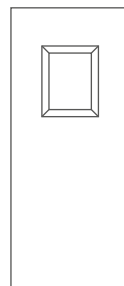

400 x 300

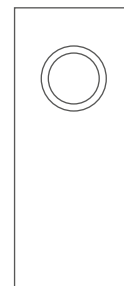

ø360

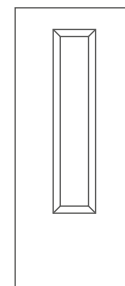

1200 x 200

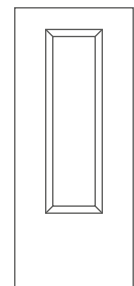

1200 x 300

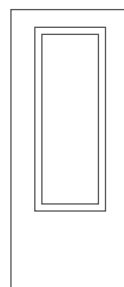

1200 x 400

\*Stability of the door leaf is an important factor, particularly in areas of temperature variance between rooms or between rooms and corridors. Any distortion of the door leaf will result in the seals not functioning correctly. With the inclusion of a minimum of 2 steel sheets and other materials, Huet door leaves offer less than 2mm of distortion. The result is a door leaf and seal which continues to perform even with wide temperature differences.

Technical Details

All sizes are in mm

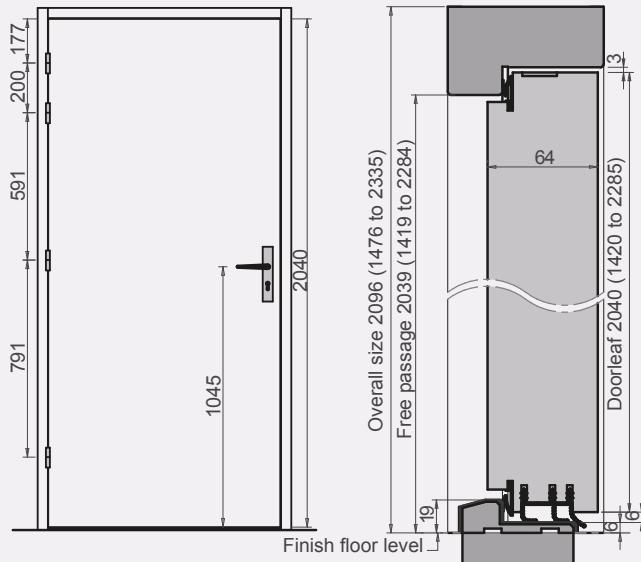

Pyramidal threshold 67x15

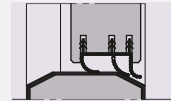

Rw 39 dB

Swiss threshold 67x19

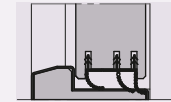

Rw 39 dB

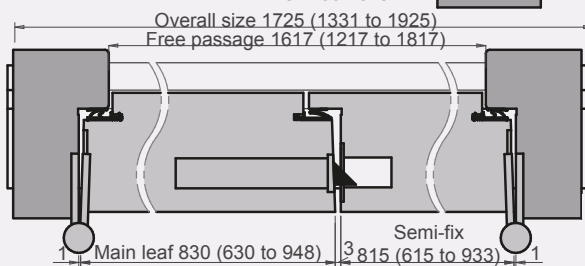
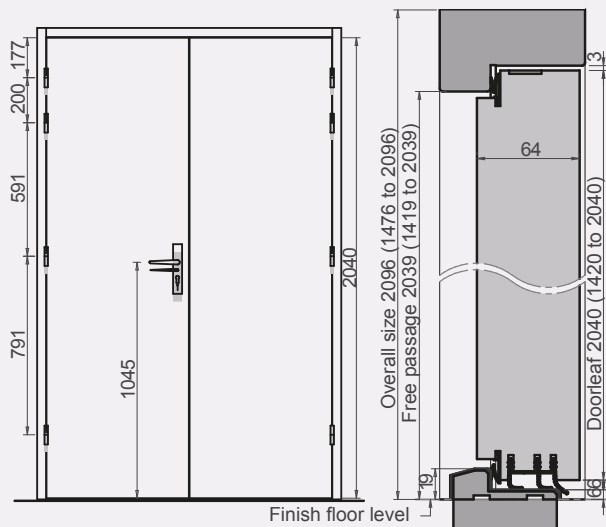
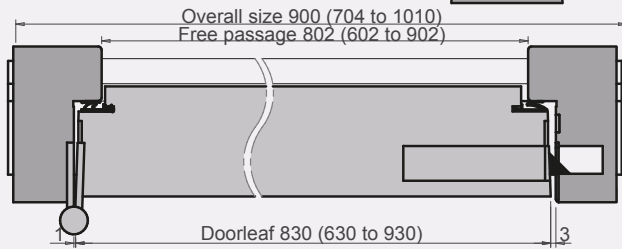

## Timber and Acoustic Door Sets

# ISADX 4260

(Single Leaf)

### Door Leaf

- Huet multi-layer acoustic core
- Thickness: 64mm hardwood stiles all round
- High stability leaf due to the inclusion of 2 steel sheets

### Door Frame

- Hardwood
- Rebated monoblock frame
- Variety of widths
- Extension linings available
- Frame can be lacquered, stained or varnished
- Frame can be wrapped with wood veneer to match door leaf facings

### Choice of Door Facings

- Primed
- Wood veneers
- Laminated
- White paint finish + other colour available by request
- Grooved to a wide choice of standard and bespoke finishes

### Ironmongery

- 4 lift-off hinges - 160 x 90mm black or chrome plated
- Cut-outs/mortices are available to suit a variety of locks and handles
- Cut-outs/mortices are available to suit a large choice of electromagnetic lock
- Spy hole
- Concealed door closer available: DORMA ITS96

### Perimeter Seals

- Intumescent seals factory fitted (within the frame and leaf)
- Combined smoke and acoustic seals fitted within the frame
- Thresholds selection

### Features



**42dB**  
(CSTB AC98.159)



**EI60** (FD60)  
(EITHER SIDE – According to BS EN 1634-1:2000)



**3c Stability\***  
(NF EN 12219)



**Smoke Seal**  
(S<sub>a</sub> Classification)  
(EN 13501-2/ BS EN 1634-3)

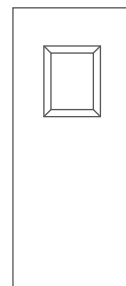

400 x 300

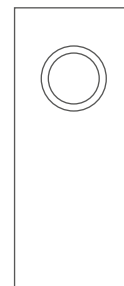

ø360

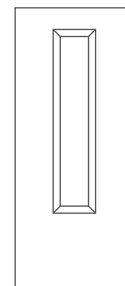

1200 x 200

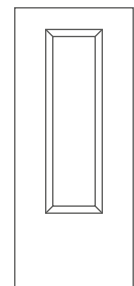

1200 x 300

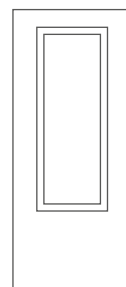

1200 x 400

\*Stability of the door leaf is an important factor, particularly in areas of temperature variance between rooms or between rooms and corridors. Any distortion of the door leaf will result in the seals not functioning correctly. With the inclusion of a minimum of 2 steel sheets and other materials, Huet door leaves offer less than 2mm of distortion. The result is a door leaf and seal which continues to perform even with wide temperature differences.

Technical Details

All sizes are in mm

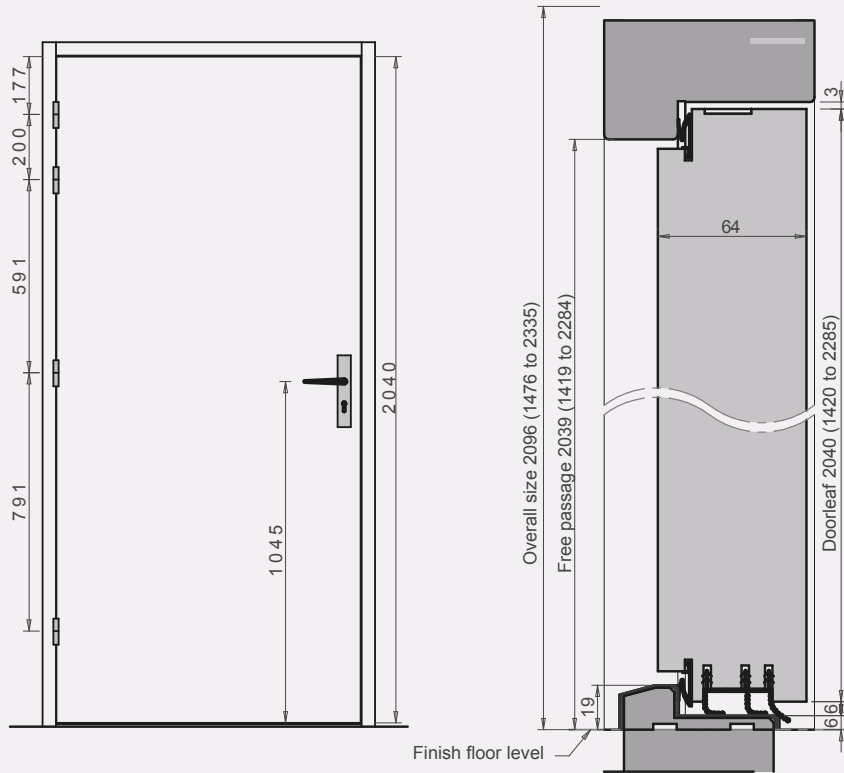

Pyramidal threshold 67x15

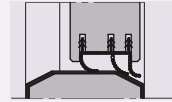

Rw 42 dB

Swiss threshold 67x19

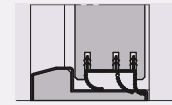

Rw 42 dB

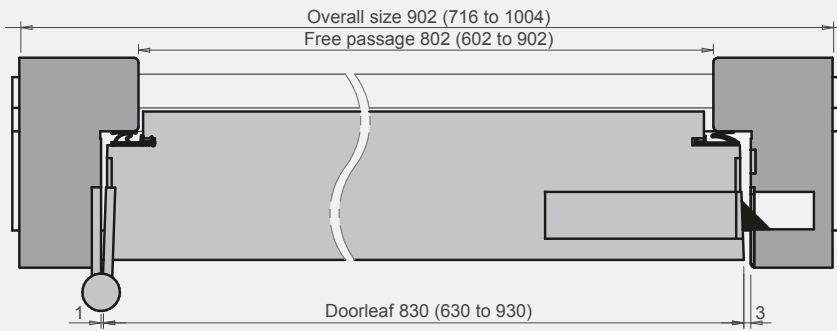

## Timber Acoustic and Security Door Sets

# APARTMENT ENTRANCE DOORSET AXIOME 39 PAS 24

(Single Leaf)

### Door Leaf

- HUET multi-layer acoustic & anti breaking core
- Thickness: 40mm concealed engineered beech stiles
- all round
- High stability leaf due to the inclusion of 2 steel sheets

### Door Frame

- Engineered beech 98 x 51mm
- Rebated monoblock frame
- Extension linings available
- Frame can be stained, varnished or fully painted
- Frame can be wrapped with wood veneer to match
- door leaf facings

### Choice of Door Facings

- Primed
- Wood veneers to match approved samples
- Laminated
- Engraved to a wide choice of standard
- and bespoke finishes
- Fully painted

### Ironmongery

- Hinges: 4 lift-off hinges or 3 butt hinges
- Lock: Vachette 5000 SPN1 A2P\* 3 points
- Cylinder: Anti snap cylinder or standard cylinder
- Escutcheon: Anti breaking escutcheon or standard
- ecutcheon
- Doorcloser option: Concealed doorcloser DORMA ITS96
- Spy hole (as an option)

### Perimeter Seals

- Intumescent seals factory fitted
- Combined smoke and acoustic seals fitted within
- the frame and leaf
- Mechanical drop seal or Flat threshold 35 x 12mm

### Features



**39dB**

(According to EN Standards)



**EI30**

(Either side according to EN/BS Standards)



**3c Stability\***



**Smoke Seal**

(S<sub>a</sub> Classification)  
(EN 13501-2/ BS EN 1634-3)



**PAS 24 Anti Breaking**

(According to BS Standards)

\*Stability of the door leaf is an important factor, particularly in areas of temperature variance between rooms or between rooms and corridors. Any distortion of the door leaf will result in the seals not functioning correctly. With the inclusion of a minimum of 2 steel sheets and other materials, Huet door leaves offer less than 2mm of distortion. The result is a door leaf and seal which continues to perform even with wide temperature differences.

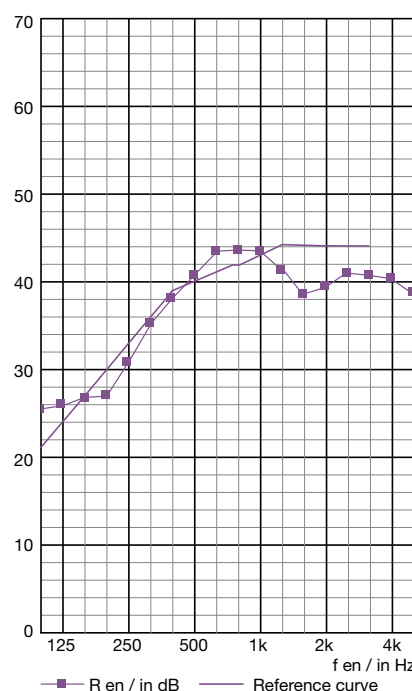

f	R
100	25,5
125	26,0
160	26,8
200	27,0
250	30,8
315	35,3
400	38,1
500	40,7
630	43,4
800	43,5
1000	43,4
1250	41,3
1600	38,6
2000	39,4
2500	41,0
3150	40,8
4000	40,4
5000	38,8
Hz	dB

(-): corrected value

(+): station limit

$R_w(C;C_{tr}) = 40(-1;-4)$  dB

For information:

$RA = R_w + C = 39$  dB

$R_{A,tr} = R_w + C_{tr} = 36$  dB

Technical Details

All sizes are in mm

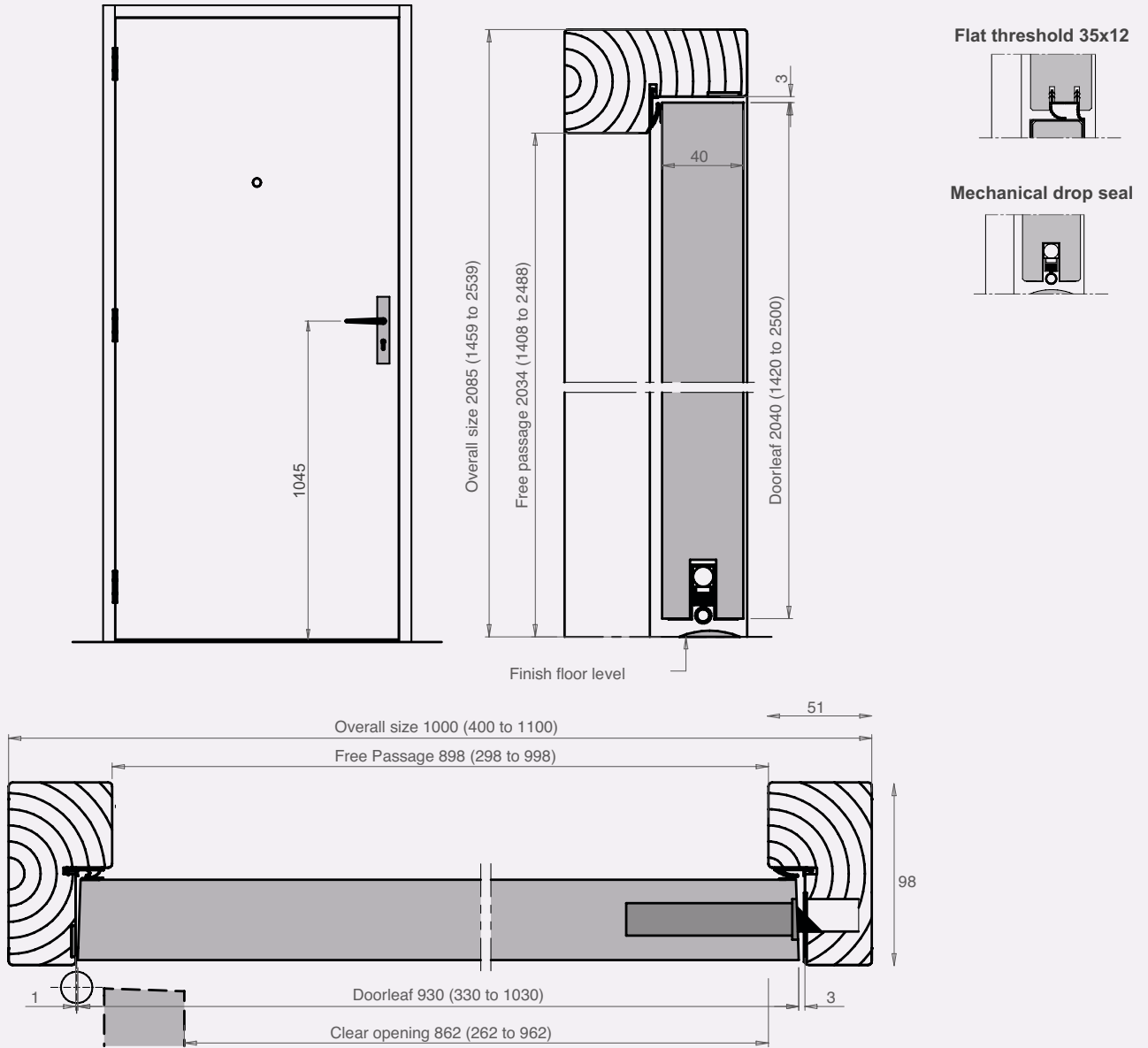

# Partnership Excellence

The high performance and extensive choice of the 'Arnold Laver Door Set Solutions' range is achieved through partnering with some of the best suppliers in the industry.

We work with market leading volume and specialist door manufacturers, acoustic, fire and décor experts to provide a vast choice of technical abilities and finishes to fit every situation.

---

These are some of the brands that help us to achieve our first-class range.

**HUET**  
HIGH PERFORMANCE DOORS

**HALSPAN**

**vicaima**  
UNEXPECTED HARMONY

**LORIENT**

**PREMDOR**

**FORMICA**

---

We would like to thank our partners for the use of their photographs within this document.





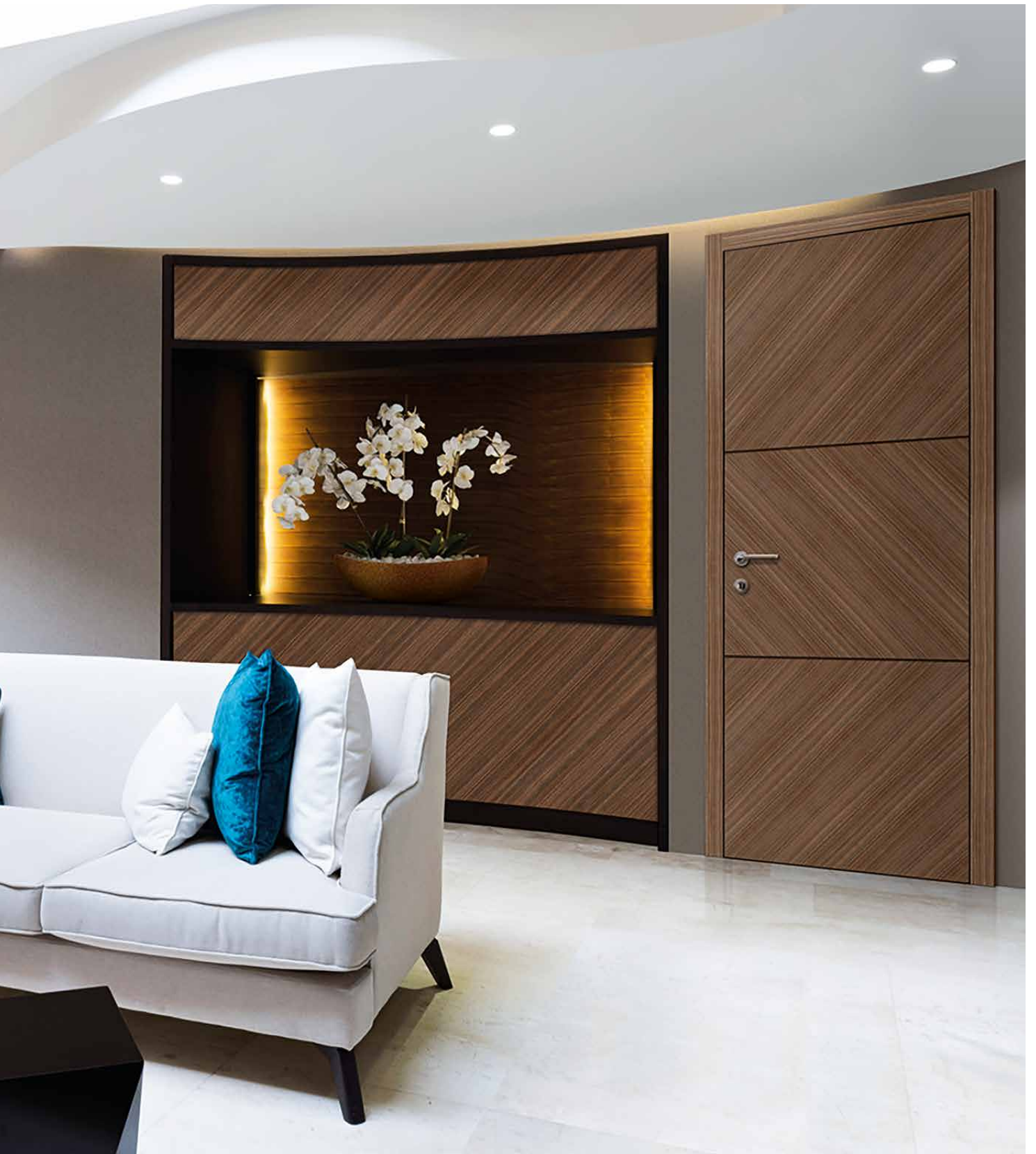





# Finishing Touches

We know that as well as giving exceptional performance, a doors' appearance is intrinsic to the overall interior design of a space.

These are some of the most popular colours but others are available so please get in touch if you can't find what you are looking for.

## Arnold Laver Veneer Range



Ash



Cherry



Oak



Steamed Beech



Walnut

Please note that the colours in this document are as accurate as the printing process allows. Please contact us for exact colour swatches.

## Formica® Colours Range

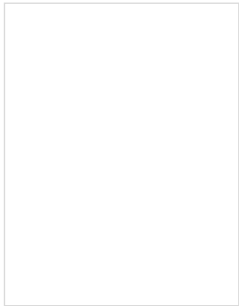

**White**  
MAT (F0949)

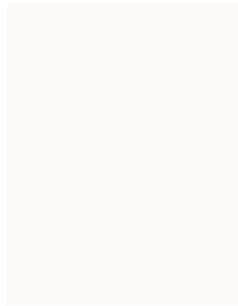

**Polar White**  
MAT (F2255)

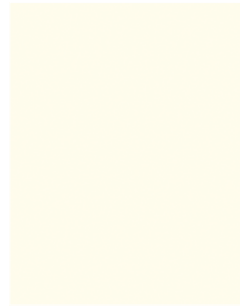

**Soft White**  
MAT (F7949)

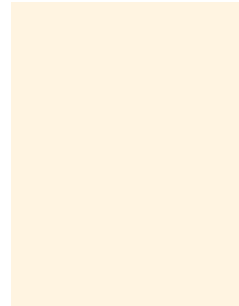

**Antique White**  
MAT (F7932)

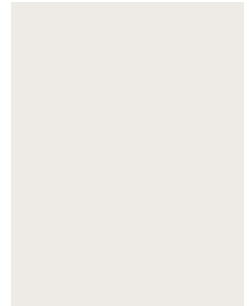

**Surf**  
MAT (F7923)

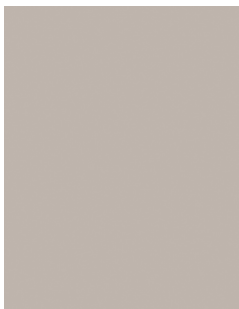

**Folkstone**  
MAT (F7927)

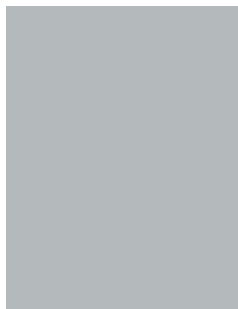

**Steel**  
MAT (F1484)

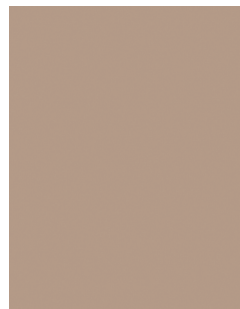

**Oyster Grey**  
MAT (F7929)

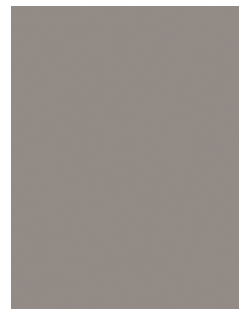

**Fog**  
MAT (F7961)

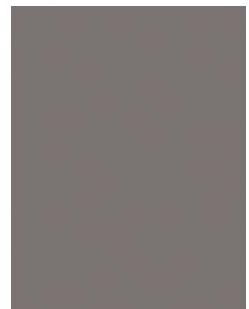

**Mouse**  
MAT (F7928)

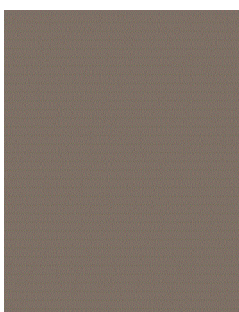

**Earth**  
MAT (F5342)

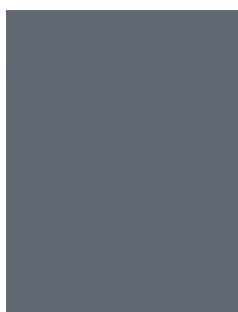

**Lead**  
MAT (F7924)



**Storm**  
MAT (F7912)



**Graphite**  
MAT (F7837)

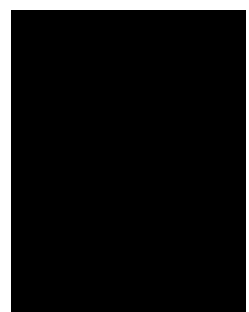

**Diamond Black**  
MAT (F2253)

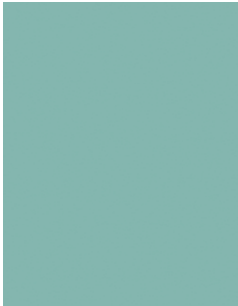

**Dusty Jade**  
MAT (F7879)



**Vibrant Green**  
MAT (F6901)



**Chrome Yellow**  
MAT (F1485)



**Spectrum Red**  
MAT (F7845)



**Viola**  
MAT (F5345)

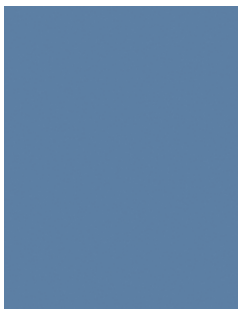

**China Blue**  
MAT (F7884)



**Tropical Blue**  
MAT (F2828)



**Denim**  
MAT (F8822)



**Marine Blue**  
MAT (F7914)



**Nocturne**  
MAT (F5323)

Formica® High Pressure Laminate (HPL) is manufactured through fusing multiple layers of impregnated paper under high pressure and temperature to create a hard-wearing, durable and hygienic surfacing material.

## Formica® Laminate Woods Range



**White Ash**  
MAT (F8841)



**Natural Ash**  
MAT (F8843)



**Clear Maple**  
MAT (F3855)



**Natural Beech**  
MAT (F2726)



**Elegant Oak**  
MAT (F5374)



**Bio-Oak**  
MAT (F7603)



**Finn Beech**  
MAT (F0190)



**Vintage Wood**  
MAT (F5372)



**Macchiato Walnut**  
MAT (F6932)



**Nocture Wood**  
MAT (F5373)



**Classic Wenge**  
LNW (F8851)



**Rural Oak**  
Premium PGN  
(F8853)



**Delano Oak**  
Premium PGN  
(F8966)



**Rattan Cane**  
Premium NAT  
(F3699)



**Smoky Brown Pear**  
Premium NAT  
(F8966)







## Huet Boreal Colour Range

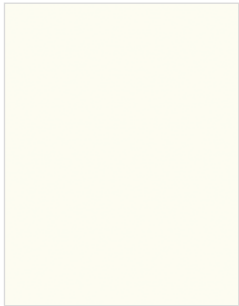

**Blanc Integral**  
(W1001)  
EGGER ST9

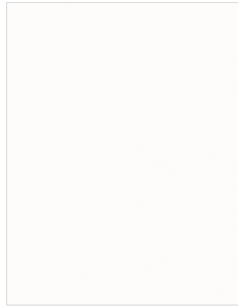

**Blanc Cumulus**  
(F2255)  
FORMICA MATTE 58



**Seringa**  
(F2273)  
FORMICA MATTE 58

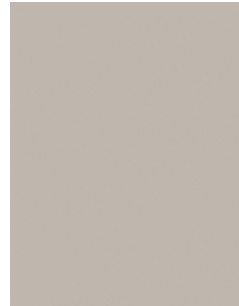

**Feutre**  
(F026)  
POLYREY FA

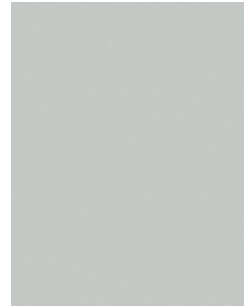

**Etain**  
(F7927)  
FORMICA MATTE 58

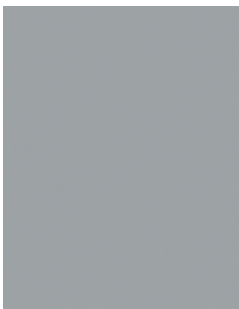

**Gris Perle**  
(G003)  
POLYREY FA



**Gris Orage**  
(G059)  
POLYREY FA

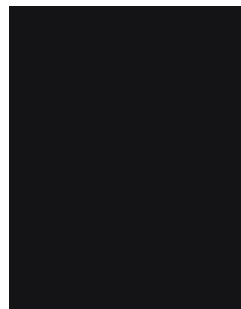

**Noir**  
(O005)  
POLYREY FA



**Pierre de Lune**  
(P001)  
POLYREY FA

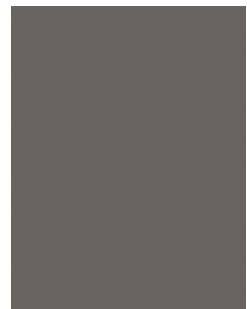

**Fer**  
(F006)  
POLYREY FA



**Tôle Zinc**  
(T069)  
POLYREY FA



**Inox Brosse**  
(I004)  
POLYREY FA



**Brushed Metal**  
(B009)  
POLYREY FA



**Cuivre Oxyde**  
(C034)  
POLYREY FA

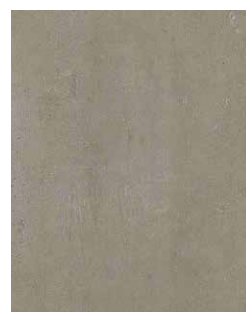

**Beton Clair**  
(C034)  
EGGER ST9



**Beton Fonce**  
(F725)  
EGGER ST9



**Grenade**  
(G024)  
POLYREY FA



**Carnaval**  
(K1238)  
FORMICA MATTE 58



**Rose Bougainvillier**  
(Y022)  
POLYREY FA



**Cassis**  
(F6903)  
FORMICA MATTE 58



**Nectarine**  
(N001)  
POLYREY FA



**Genet**  
(F7940)  
FORMICA MATTE 58



**Pomme Verte**  
(P092)  
POLYREY FA

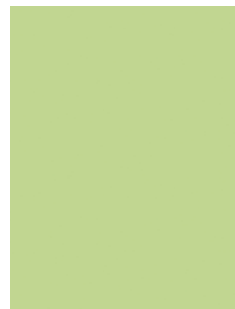

**Kiwi**  
(K001)  
POLYREY FA

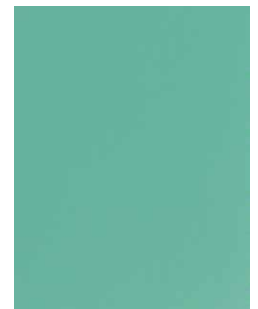

**Maui**  
(F5347)  
FORMICA MATTE 58

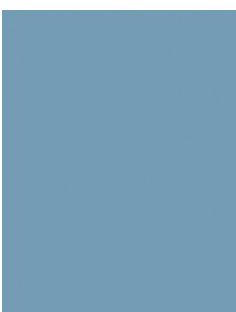

**Lavande**  
(F7884)  
FORMICA MATTE 58



**Bleu Flash**  
(B001)  
POLYREY FA



**Bleu Caraïbes**  
(B086)  
POLYREY FA

## Huet Boreal Bois Range



**Erable Blanc**  
(E009)  
POLYREY FA



**Acacia De Lakeland  
Creme** (H1277)  
EGGER ST9



**Bouleau Naturel**  
(H1727)  
EGGER ST15



**Bouleau de  
Maine** (H1733)  
EGGER ST9



**Ceruse Clair**  
(S040)  
POLYREY FA



**Chêne Quebec**  
(C105)  
POLYREY EXM



**Chêne Clair horiz.**  
(C102)  
POLYREY EXM



**Chêne Brun horiz.**  
(C101)  
POLYREY EXM



**Chêne de Ferrare**  
(H1334)  
EGGER ST9



**Chêne Lave**  
(C103)  
POLYREY FA



**Fruitier Cendre**  
(F012)  
POLYREY FA



**Erable D'amerique**  
(F1297)  
FORMICA MATTE 58



**Natural Cane**  
(F6930)  
FORMICA NATUREL



**Hêtre de  
Bourgogne** (F2887)  
FORMICA MATTE 58



**Hêtre de Provence**  
(H027)  
POLYREY FA

## Huet Boreal Bois Range



**Calvados Naturel**  
(H1950)  
EGGER ST15



**Poirier du Limousin**  
(F2884)  
FORMICA MATTE 58



**Merisier**  
(H1706)  
EGGER ST15



**Calvados Sardoine**  
(H1951)  
EGGER ST15



**Noyer Ombre**  
(N026)  
POLYREY FA



**Noyer du Perigord**  
(N003)  
POLYREY FA



**Chêne Royal Anthracite** (H3306)  
EGGER ST9



**Etimoe Classique**  
(F1293)  
FORMICA MATTE 58



**Banian Bianchi**  
(B100)  
POLYREY FA



**Banian Noirci**  
(B101)  
POLYREY FA



**Wenge**  
(F1614)  
FORMICA MATTE 58





# *Arnold Laver*

Joinery Department  
Oxclose Park Road North  
Sheffield  
South Yorkshire  
S20 8GN

tel: 0114 276 4880  
email: [joineryestimating@laver.co.uk](mailto:joineryestimating@laver.co.uk)  
[laver.co.uk](http://laver.co.uk)